

Digital Multimeter

OPERATING INSTRUCTIONS



CP7678

Index

Safety Precautions	2	Starting / Charging System Testing	15
Vehicle Service Information	3	- No Load Battery Test	15
Visual Inspection	3	- Engine Off Battery Current Draw	16
Warranty	72	- Cranking Voltage/Battery Load Test ...	17
		- Voltage Drops	18
		- Charging System Voltage Test.....	19
1. Multimeter Basic Functions		Ignition System Testing	20
Functions and Display Definitions	4	- Ignition Coil Testing	20
Setting the Range	6	- Ignition System Wires	22
Battery and Fuse Replacement	7	- Hall Effect Sensors/Switches	23
Measuring DC Voltage	8	- Magnetic Pick-Up Coils	24
Measuring Resistance	8	- Reluctance Sensors	24
Measuring DC Current	9	- Ignition Coil Switching Action	25
Testing for Continuity	10	Fuel System Testing	26
Testing Diodes	10	- Testing GM C-3 Mixture Control Solenoid Dwell	26
Measuring Engine RPM (TACH)	11	- Measuring Fuel Injector Resistance	27
Measuring Dwell	12	Testing Engine Sensors	28
Measuring Duty Cycle	12	- Oxygen (O ₂) Type Sensors	28
		- Temperature Type Sensors	30
		- Position Type Sensors – Throttle and EGR Valve Position, Vane Air Flow	31
2. Automotive Testing with the CP7678		- Manifold Absolute Pressure (MAP) and Barometric Pressure (BARO) Sensors	32
General Testing	13	- Mass Air Flow (MAF) Sensors	34
- Testing Fuses	13		
- Testing Switches	13		
- Testing Solenoids and Relays	14		

SAFETY GUIDELINES

TO PREVENT ACCIDENTS THAT COULD RESULT IN SERIOUS INJURY AND/OR DAMAGE TO YOUR VEHICLE OR TEST EQUIPMENT, CAREFULLY FOLLOW THESE SAFETY RULES AND TEST PROCEDURES

- Always wear approved eye protection.
- Always operate the vehicle in a well ventilated area. Do not inhale exhaust gases – they are very poisonous!
- Always keep yourself, tools and test equipment away from all moving or hot engine parts.
- Always make sure the vehicle is in **park** (Automatic transmission) or **neutral** (manual transmission) and that the **parking brake is firmly set**. Block the drive wheels.
- Never lay tools on vehicle battery. You may short the terminals together causing harm to yourself, the tools or the battery.
- Never smoke or have open flames near vehicle. Vapors from gasoline and charging battery are highly flammable and explosive.
- Never leave vehicle unattended while running tests.
- Always keep a fire extinguisher suitable for gasoline/electrical/chemical fires handy.
- Always use extreme caution when working around the ignition coil, distributor cap, ignition wires, and spark plugs. These components contain **High Voltage** when the engine is running.
- Always turn ignition key OFF when connecting or disconnecting electrical components, unless otherwise instructed.
- Always follow vehicle manufacturer's warnings, cautions and service procedures.

CAUTION:

Some vehicles are equipped with safety air bags. You *must* follow vehicle service manual cautions when working around the air bag components or wiring. If the cautions are not followed, the air bag may open up unexpectedly, resulting in personal injury. Note that the air bag can still open up several minutes after the ignition key is off (or even if the vehicle battery is disconnected) because of a special energy reserve module.

All information, illustrations and specifications contained in this manual are based on the latest information available from industry sources at the time of publication. No warranty (expressed or implied) can be made for its accuracy or completeness, nor is any responsibility assumed by Actron Manufacturing Co. or anyone connected with it for loss or damages suffered through reliance on any information contained in this manual or misuse of accompanying product. Actron Manufacturing Co. reserves the right to make changes at any time to this manual or accompanying product without obligation to notify any person or organization of such changes.

Vehicle Service Manual – Sources For Service Information

The following is a list of sources to obtain vehicle service information for your specific vehicle.

- Contact your local Automotive Dealership Parts Department.
- Contact local retail auto parts stores for aftermarket vehicle service information.
- Contact your local library. Libraries often allow you to check-out automotive service manuals.

Do a Thorough Visual Inspection

Do a thorough visual and “hands-on” underhood inspection before starting any diagnostic procedure! You can find the cause of many problems by just looking, thereby saving yourself a lot of time.

- Has the vehicle been serviced recently? Sometimes things get reconnected in the wrong place, or not at all.
- Don't take shortcuts. Inspect hoses and wiring which may be difficult to see due to location.
- Inspect the air cleaner and ductwork for defects.
- Check sensors and actuators for damage.
- Inspect ignition wires for:
 - Damaged terminals.
 - Split or cracked spark plug boots
 - Splits, cuts or breaks in the ignition wires and insulation.
- Inspect all vacuum hoses for:
 - Correct routing. Refer to vehicle service manual, or Vehicle Emission Control Information(VECI) decal located in the engine compartment.
 - Pinches and kinks.
 - Splits, cuts or breaks.
- Inspect wiring for:
 - Contact with sharp edges.
 - Contact with hot surfaces, such as exhaust manifolds.
 - Pinched, burned or chafed insulation.
 - Proper routing and connections.
- Check electrical connectors for:
 - Corrosion on pins.
 - Bent or damaged pins.
 - Contacts not properly seated in housing.
 - Bad wire crimps to terminals.

Section 1. Multimeter Basic Functions

Digital multimeters or DMMs have many special features and functions. This section defines these features and functions, and explains how to use these functions to make various measurements.



Alligator Clip Adapters

Some multimeter tests and measurements are more easily done using alligator clips instead of test prods. For these tests, push the crimp end of the alligator clip onto the test prod. If the crimp on the alligator clip becomes loose, then remove the alligator clip from the test prod and re-crimp using a pair of pliers.

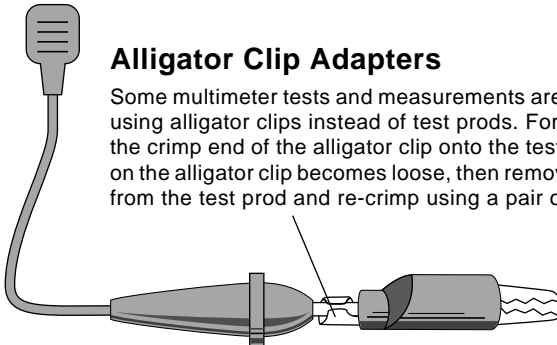

Functions and Display Definitions

1. ROTARY SWITCH

Switch is rotated to turn multimeter ON/OFF and select a function.

2. DC VOLTS

This function is used for measuring DC (Direct Current) Voltages in the range of 0 to 200V.

3. OHMS

This function is used for measuring the resistance of a component in an electrical circuit in the range of 0.1Ω to 20MΩ. (Ω is the electrical symbol for Ohms)

4. DIODE CHECK

This function is used to check whether a diode is good or bad.

5. CONTINUITY TESTS

It is also used for fast continuity checks of wires and terminals. An audible tone will sound if a wire and terminal are good.

6. DC AMPS

This function is used for measuring DC (Direct Current) Amps in the range of 0 to 15A.

7. TEST LEAD JACKS

BLACK Test Lead is always inserted in the COM jack.

RED Test Lead is inserted in the jack corresponding to the multimeter rotary switch setting.



DC AMPS

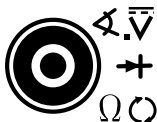

DC VOLTS
OHMS
DIODES
CONTINUITY



TACH
DWELL
DUTY CYCLE

8. TACH

This function is used for measuring engine speed (RPM).

9. DWELL

This function is used for measuring DWELL on distributor ignition systems, and solenoids.

10. DUTY CYCLE

This function is used for measuring DUTY CYCLE on relays, solenoids, and other ON/OFF types of devices.

11. DISPLAY

Used to display all measurements and multimeter information.



Low Battery – If this symbol appears in the lower left corner of the display, then replace the internal 9V battery. (See Fuse and Battery replacement on page 7.)

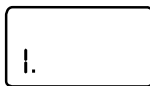

Overrange Indication – If “1” or “-1” appears on the left side of the display, then the multimeter is set to a range that is too small for the present measurement being taken. Increase the range until this disappears. If it does not disappear after all the

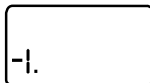

ranges for a particular function have been tried, then the value being measured is too large for the multimeter to measure. (See Setting the Range on page 6.)

Automatic Power Off

The multimeter will automatically turn itself off after approximately thirty (30) minutes if the rotary switch has not been rotated. Momentarily change the rotary switch position to restore normal operation.

Zero Adjustment

The multimeter will automatically zero on the Volts, Amps and RPM functions.

Automatic Polarity Sensing

The multimeter display will show a minus (-) sign on the DC Volts and DC Amps functions when test lead hook-up is reversed.

Always connect TEST LEADS to the multimeter before connecting them to the circuit under test!!

Setting the Range

Two of the most commonly asked questions about digital multimeters are What does Range mean? and How do I know what Range the multimeter should be set to?

What Does Range mean?

Range refers to the largest value the multimeter can measure with the rotary switch in that position. If the multimeter is set to the 20V DC range, then the highest voltage the multimeter can measure is 20V in that range.

EXAMPLE: Measuring Vehicle Battery Voltage (See Fig. 1)

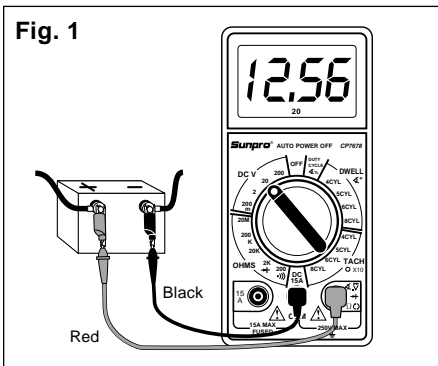

Let's assume the multimeter is connected to the battery and set to the 20V range.

The display reads 12.56. This means there is 12.56V across the battery terminals.

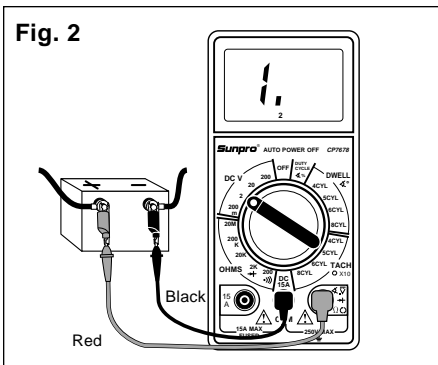

Now assume we set the multimeter to the 2V range. (See Fig. 2)

The multimeter display now shows a "1" and nothing else. This means the multimeter is being **overranged** or in other words the value being measured is larger than the current range. The range should be increased until a value is shown on the display. If you are in the highest range and the multimeter is still showing that it is overranging, then the value being measured is too large for the multimeter to measure.

How do I know what Range the multimeter should be set to?

The multimeter should be set in the lowest possible range without overranging.

EXAMPLE: Measuring an unknown resistance

Let's assume the multimeter is connected to an engine coolant sensor with unknown resistance. (See Fig. 3)

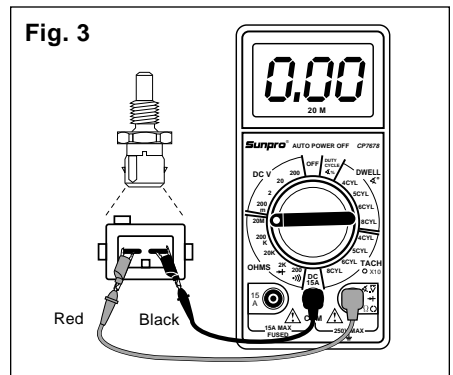

Start by setting the multimeter to the largest OHM range. The display reads 0.0Ω or a short circuit.

This sensor can't be shorted so reduce the range setting until you get a value of resistance.

At the 200KΩ range the multimeter measured a value of 4.0. This means there is 4KΩ of resistance across the engine coolant sensor terminals. (See Fig. 4)

Fig. 4

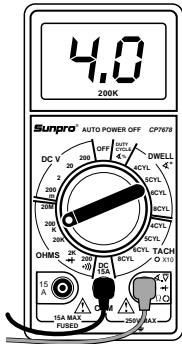

measurement by either increasing or decreasing the number of digits after the decimal point.

Battery and Fuse Replacement

Important: A 9 Volt battery must be installed before using the digital multimeter. (see procedure below for installation)

Battery Replacement

1. Turn multimeter rotary switch to OFF position.
2. Remove test leads from multimeter.
3. Remove three screws from back of multimeter.
4. Remove back cover.
5. Install a new 9 Volt battery.
6. Re-assemble multimeter.

Fuse Replacement

1. Turn multimeter rotary switch to OFF position.
2. Remove test leads from multimeter.
3. Remove three screws from back of multimeter.
4. Remove back cover.
5. Remove battery.
6. Remove fuse located on top of battery clip.
7. Replace fuse with same size and type as originally installed.
Use a 5mm X 20mm, 15A, 250V, fast blow fuse.
8. Re-assemble multimeter.

If we change the multimeter to the 20KΩ range (See Fig. 5) the display shows a value of 3.87KΩ. The actual value of resistance is 3.87KΩ and not 4KΩ that was measured in the 200KΩ range. This is very important because if the manufacturer specifications say that the sensor should read 3.8-3.9KΩ at 70°F then the sensor would be defective, but at the 20KΩ range it would test good.

Fig. 5

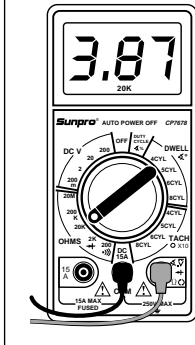

Now set the multimeter to the 2KΩ range. (See Fig. 6) The display will indicate an overrange condition because 3.87KΩ is larger than 2KΩ.

This example shows that by decreasing the range you increase the accuracy of your measurement. When you change the range, you change the location of the decimal point. This changes the accuracy of the

Fig. 6

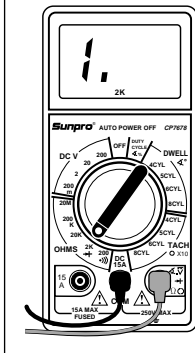

Measuring DC Voltage

This multimeter can be used to measure DC voltages in the range from 0 to 200V. You can use this multimeter to do any DC voltage measurement called out in the vehicle service manual. The most common applications are measuring voltage drops, and checking if the correct voltage arrived at a sensor or a particular circuit.

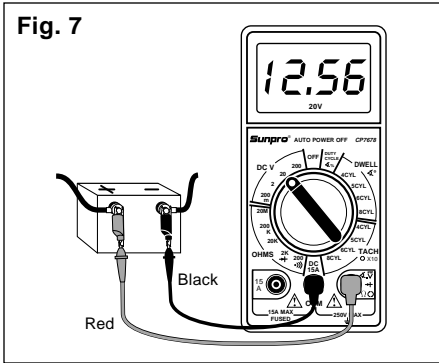

To measure DC Voltages (see Fig. 7):

1. Insert **BLACK** test lead into **COM** test lead jack.
2. Insert **RED** test lead into $\text{V}\Omega$ test lead jack.
3. Connect **RED** test lead to positive (+) side of voltage source.
4. Connect **BLACK** test lead to negative (-) side of voltage source.

NOTE: If you don't know which side is positive (+) and which side is negative (-), then arbitrarily connect the RED test lead to one side and the BLACK to the other. The multimeter automatically senses polarity and will display a minus (-) sign when negative polarity is measured. If you switch the RED and BLACK test leads, positive polarity will now be indicated on the display. Measuring negative voltages causes no harm to the multimeter.

5. Turn multimeter rotary switch to desired voltage range.

If the approximate voltage is unknown, start at the largest voltage range and de-

crease to the appropriate range as required. (See Setting the Range on page 6)

6. **View reading on display - Note range setting for correct units.**

NOTE: 200mV = 0.2V

Measuring Resistance

Resistance is measured in electrical units called ohms (Ω). The digital multimeter can measure resistance from 0.1 Ω to 20M Ω or (20,000,000 ohms). Infinite resistance is shown with a "1" on the left side of display (See Setting the Range on page 6). You can use this multimeter to do any resistance measurement called out in the vehicle service manual. Testing ignition coils, spark plug wires, and some engine sensors are common uses for the OHMS (Ω) function.

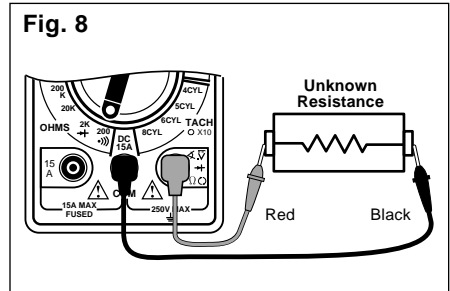

To measure Resistance (see Fig. 8):

1. **Turn circuit power OFF.**
To get an accurate resistance measurement and avoid possible damage to the digital multimeter and electrical circuit under test, turn off all electrical power in the circuit where the resistance measurement is being taken.
2. **Insert BLACK test lead into COM test lead jack.**
3. **Insert RED test lead into $\text{V}\Omega$ test lead jack.**
4. **Turn multimeter rotary switch to 200 Ω range.**

Touch RED and BLACK multimeter leads together and view reading on display.

Display should read typically 0.2Ω to 1.5Ω. If display reading was greater than 1.5Ω, check both ends of test leads for bad connections. If bad connections are found, replace test leads.

5. Connect RED and BLACK test leads across component where you want to measure resistance.

When making resistance measurements, polarity is not important. The test leads just have to be connected across the component.

6. Turn multimeter rotary switch to desired OHM range.

If the approximate resistance is unknown, start at the largest OHM range and decrease to the appropriate range as required. (See Setting the Range on page 6)

7. View reading on display - Note range setting for correct units.

NOTE: 2KΩ = 2,000Ω; 2MΩ = 2,000,000Ω

If you want to make precise resistance measurements, then subtract the test lead resistance found in Step 4 above from the display reading in Step 7. It is a good idea to do this for resistance measurements less than 10Ω.

testing, current measurements must be made with the multimeter in series with the component. Isolating current drains and short circuits are some DC Current applications.

To measure DC Current (see Fig. 9):

1. Insert BLACK test lead into COM test lead jack.

2. Insert RED test lead into "15A" test lead jack.

3. Disconnect or electrically open circuit where you want to measure current.

This is done by:

- Disconnecting wiring harness.
- Disconnecting wire from screw-on type terminal.
- Unsolder lead from component if working on printed circuit boards.
- Cut wire if there is no other possible way to open electrical circuit.

4. Connect RED test lead to one side of disconnected circuit.

5. Connect BLACK test lead to remaining side of disconnected circuit.

6. Turn multimeter rotary switch to 15A DC position.

7. View reading on display.

If minus (-) sign appears on display, then reverse RED and BLACK test leads.

Measuring DC Current

This multimeter can be used to measure DC current in the range from 0 to 15A. If the current you are measuring exceeds 15A, the internal fuse will blow (see Fuse Replacement on page 7). Unlike voltage and resistance measurements where the multimeter is connected across the component you are

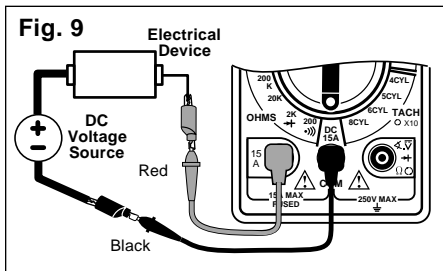

Measuring Dwell

Dwell measuring was extremely important on breaker point ignition systems of the past. It referred to the length of time, in degrees, that the breaker points remained closed, while the camshaft was rotating. Today's vehicles use electronic ignition and dwell is no longer adjustable. Another application for dwell is in testing the mixture control solenoid on GM feedback carburetors.

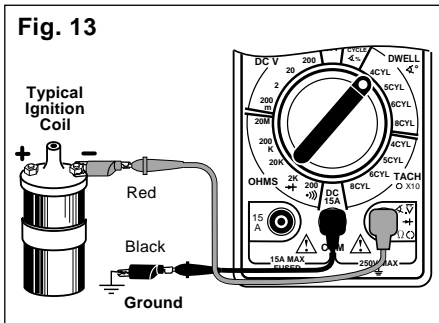

To measure Dwell (see Fig. 13):

1. Insert **BLACK** test lead into COM test lead jack.
2. Insert **RED** test lead into $\text{V} \rightarrow \Omega \text{C}$ test lead jack.
3. Connect **RED** test lead to **DWELL** signal wire.
 - If measuring DWELL on breaker point ignition systems, connect RED test lead to negative side of primary ignition coil. (refer to vehicle service manual for location of ignition coil)
 - If measuring DWELL on GM mixture control solenoids, connect RED test lead to ground side or computer driven side of solenoid. (refer to vehicle service manual for solenoid location)
 - If measuring DWELL on any arbitrary ON/OFF device, connect RED test lead to side of device that is being switched ON/OFF.
4. Connect **BLACK** test lead to a good vehicle ground.

5. Turn multimeter rotary switch to correct **DWELL CYLINDER** position.
6. View reading on display.

Measuring Duty Cycle

Duty Cycle refers to the percentage of time a signal is "ON" versus "OFF". A signal that is "ON" half the time has a 50% Duty Cycle. Duty Cycle is useful for checking solenoids, relays, switches, fuel injectors and any other component that is switched "ON" and "OFF".

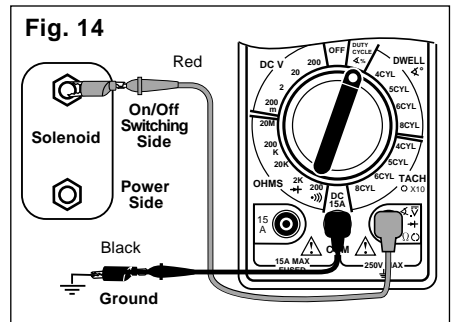

To measure Duty Cycle (see Fig. 14):

1. Insert **BLACK** test lead into COM test lead jack.
2. Insert **RED** test lead into $\text{V} \rightarrow \Omega \text{C}$ test lead jack.
3. Connect **RED** test lead to **ON/OFF** switching side of device.
4. Connect **BLACK** test lead to a good vehicle ground.
5. Turn multimeter rotary switch to **DUTY CYCLE** position.
6. View reading on display.

Section 2. Automotive Testing

The digital multimeter is a very useful tool for trouble-shooting automotive electrical systems. This section describes how to use the digital multimeter to test the starting and charging system, ignition system, fuel system, and engine sensors. The digital multimeter can also be used for general testing of fuses, switches, solenoids, and relays.

General Testing

The digital multimeter can be used to test fuses, switches, solenoids, and relays.

Testing Fuses

This test checks to see if a fuse is blown. You can use this test to check the internal 15A fuse inside the digital multimeter.

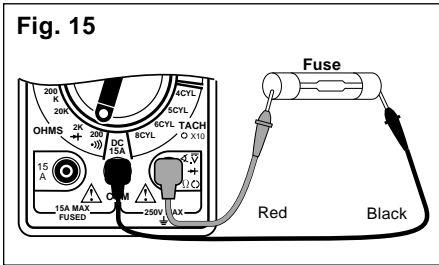

To test Fuses (see Fig. 15):

1. Insert **BLACK** test lead into **COM** test lead jack.
2. Insert **RED** test lead into $\text{V} \rightarrow \Omega$ test lead jack.
3. Turn multimeter rotary switch to **200 Ω** function.
4. Touch **RED** and **BLACK** test leads together to test continuity.
Listen for tone to verify proper operation.
5. Connect **RED** and **BLACK** test leads to opposite ends of fuse.

Listen for tone:

- If you hear tone - Fuse is good.
- If you don't hear tone - Fuse is blown and needs to be replaced.

NOTE: Always replace blown fuses with same type and rating.

Testing Switches

This test checks to see if a switch "Opens" and "Closes" properly.

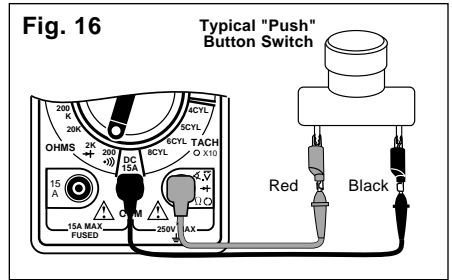

To test Switches (see Fig. 16):

1. Insert **BLACK** test lead into **COM** test lead jack.
2. Insert **RED** test lead into $\text{V} \rightarrow \Omega$ test lead jack.
3. Turn multimeter rotary switch to **200 Ω** function.
4. Touch **RED** and **BLACK** test leads together to test continuity.
Listen for tone to verify proper operation.
5. Connect **BLACK** test lead to one side of switch.
6. Connect **RED** test lead to other side of switch.
Listen for tone:
 - If you hear tone - The switch is closed.
 - If you don't hear tone - The switch is open.
7. Operate switch.
Listen for tone:

- **If you hear tone** - The switch is closed.
- **If you don't hear tone** - The switch is open.

8. Repeat Step 7 to verify switch operation.

Good Switch: Tone turns ON and OFF as you operate switch.

Bad Switch: Tone always ON or tone always OFF as you operate switch.

Testing Solenoids and Relays

This test checks to see if a solenoid or relay have a broken coil. If the coil tests good, it is still possible that the relay or solenoid are defective. The relay can have contacts that are welded or worn down, and the solenoid may stick when the coil is energized. This test does not check for those potential problems.

4. **Touch RED and BLACK test leads together and listen for tone.**
5. **Connect BLACK test lead to one side of coil.**
6. **Connect RED test lead to other side of coil.**
7. **View reading on display.**

- Typical solenoid / relay coil resistances are 200Ω or less.
- Refer to vehicle service manual for your vehicles resistance range.

8. Test Results

Good Solenoid / Relay Coil: Display in Step 7 is within manufacturers specification.

Bad Solenoid / Relay Coil:

- Display in Step 7 is not within manufacturers specifications.
- Display reads overrange on every ohms range indicating an open circuit.

NOTE: Some relays and solenoids have a diode placed across the coil. To test this diode see Testing Diodes on page 10.

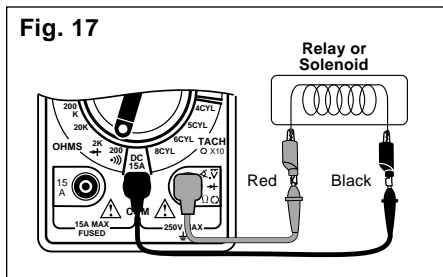

Fig. 17

To test Solenoids and Relays (see Fig. 17):

1. **Insert BLACK test lead into COM test lead jack.**
2. **Insert RED test lead into Ω/V test lead jack.**
3. **Turn multimeter rotary switch to 200 Ω range.**

Most solenoids and relay coil resistances are less than 200Ω. If meter overranges, turn multimeter rotary switch to next higher range. (see Setting the Range on page 6)

Starting/Charging System Testing

The starting system “turns over” the engine. It consists of the battery, starter motor, starter solenoid and/or relay, and associated wiring and connections. The charging system keeps the battery charged when the engine is running. This system consists of the alternator, voltage regulator, battery, and associated wiring and connections. The digital multimeter is a useful tool for checking the operation of these systems.

No Load Battery Test

Before you do any starting/charging system checks, you must first test the battery to make sure it is fully charged.

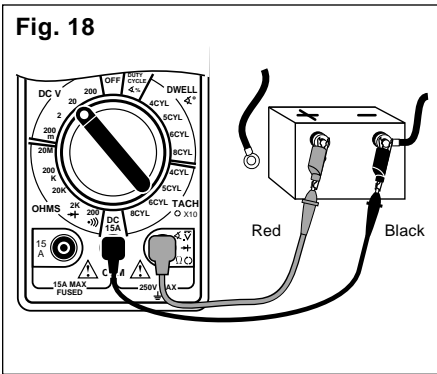

Test Procedure (see Fig. 18):

1. Turn Ignition Key OFF.
2. Turn ON headlights for 10 seconds to dissipate battery surface charge.
3. Insert BLACK test lead into COM test lead jack.
4. Insert RED test lead into $\text{V}\rightarrow\Omega$ test lead jack.

5. Disconnect positive (+) battery cable.
6. Connect RED test lead to positive (+) terminal of battery.
7. Connect BLACK test lead to negative (-) terminal of battery.
8. Turn multimeter rotary switch to 20V DC range.
9. View reading on display.
10. Test Results.

Compare display reading in Step 9 with chart below.

Voltage	Percent Battery is Charged
12.60V or greater	100%
12.45V	75%
12.30V	50%
12.15V	25%

If battery is not 100% charged, then charge it before doing anymore starting/charging system tests.

Engine Off Battery Current Draw

This test measures the amount of current being drawn from the battery when the ignition key and engine are both off. This test helps to identify possible sources of excessive battery current drain, which could eventually lead to a "dead" battery.

1. Turn Ignition Key and all accessories OFF.

Make sure trunk, hood, and dome lights are all OFF.

(See Fig. 19)

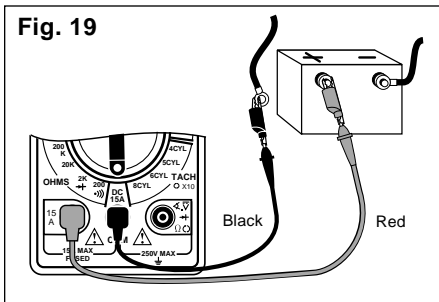

2. Insert BLACK test lead into COM test lead jack.

3. Insert RED test lead into "15A" test lead jack.

4. Disconnect positive (+) battery cable.

5. Connect RED test lead to positive (+) battery terminal.

6. Connect BLACK test lead to positive (+) battery cable.

NOTE: Do not start vehicle during this test, because multimeter damage may result.

7. Turn multimeter rotary switch to 15A DC position.

8. View reading on display.

- Typical current draw is 100mA. (1mA = 0.001A)

- Refer to vehicle service manual for manufacturers specific Engine Off Battery Current Draw.

NOTE: Radio station presets and clocks are accounted for in the 100mA typical current draw.

9. Test Results.

Normal Current Draw: Display reading in Step 8 is within manufacturers specifications.

Excessive Current Draw:

- Display reading in Step 8 is well outside manufacturers specifications.

- Remove Fuses from fuse box one at a time until source of excessive current draw is located.

- Non-Fused circuits such as headlights, relays, and solenoids should also be checked as possible current drains on battery.

- When source of excessive current drain is found, service as necessary.

Cranking Voltage - Battery Load Test

This test checks the battery to see if it is delivering enough voltage to the starter motor under cranking conditions.

Fig. 20

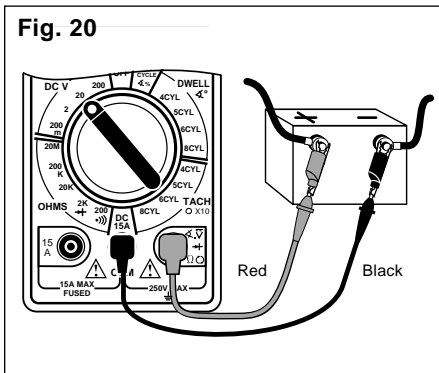

Test Procedure (see Fig. 20):

- 1. Disable ignition system so vehicle won't start.**

Disconnect the primary of the ignition coil or the distributor pick-up coil or the cam/crank sensor to disable the ignition system. Refer to vehicle service manual for disabling procedure.

- 2. Insert BLACK test lead into COM test lead jack.**
- 3. Insert RED test lead into $\text{V} \rightarrow \Omega \text{C}$ test lead jack.**
- 4. Connect RED test lead to positive (+) terminal of battery.**

- 5. Connect BLACK test lead to negative (-) terminal of battery.**
- 6. Turn multimeter rotary switch to 20V DC range.**
- 7. Crank engine for 15 seconds continuously while observing display.**
- 8. Test Results.**

Compare display reading in Step 7 with chart below.

Voltage	Temperature
9.6V or greater	70 °F and Above
9.5V	60 °F
9.4V	50 °F
9.3V	40 °F
9.1V	30 °F
8.9V	20 °F
8.7V	10 °F
8.5V	0 °F

If voltage on display corresponds to above voltage vs. temperature chart, then cranking system is normal.

If voltage on display does not correspond to chart, then it is possible that the battery, battery cables, starting system cables, starter solenoid, or starter motor are defective.

Voltage Drops

This test measures the voltage drop across wires, switches, cables, solenoids, and connections. With this test you can find excessive resistance in the starter system. This resistance restricts the amount of current that reaches the starter motor resulting in low battery load voltage and a slow cranking engine at starting.

Test Procedure (see Fig. 21):

1. Disable ignition system so vehicle won't start.

Disconnect the primary of the ignition coil or the distributor pick-up coil or the cam/crank sensor to disable the ignition system. Refer to vehicle service manual for disabling procedure.

2. Insert BLACK test lead into COM test lead jack.

3. Insert RED test lead into $\nabla V \rightarrow \Omega \text{ } \text{}$ test lead jack.

4. Connect test leads.

Refer to Typical Cranking Voltage Loss Circuit (Fig. 21).

- Connect RED and BLACK test leads alternately between 1 & 2, 2 & 3, 4 & 5, 5 & 6, 6 & 7, 7 & 8, 8 & 9, and 8 & 10.

5. Turn multimeter rotary switch to 200mV DC range.

If multimeter overranges, turn multimeter rotary switch to the 2V DC range. (See Setting the Range on page 6)

6. Crank engine until steady reading is on display.

- Record results at each point as displayed on multimeter.
- Repeat Step 4 & 5 until all points are checked.

7. Test Results –

Estimated Voltage Drop of Starter Circuit Components

Component	Voltage
Switches	300mV
Wire or Cable	200mV
Ground	100mV
Battery Cable Connectors	50mV
Connections	0.0V

- Compare voltage readings in Step 6 with above chart.
- If any voltages read high, inspect component and connection for defects.
- If defects are found, service as necessary.

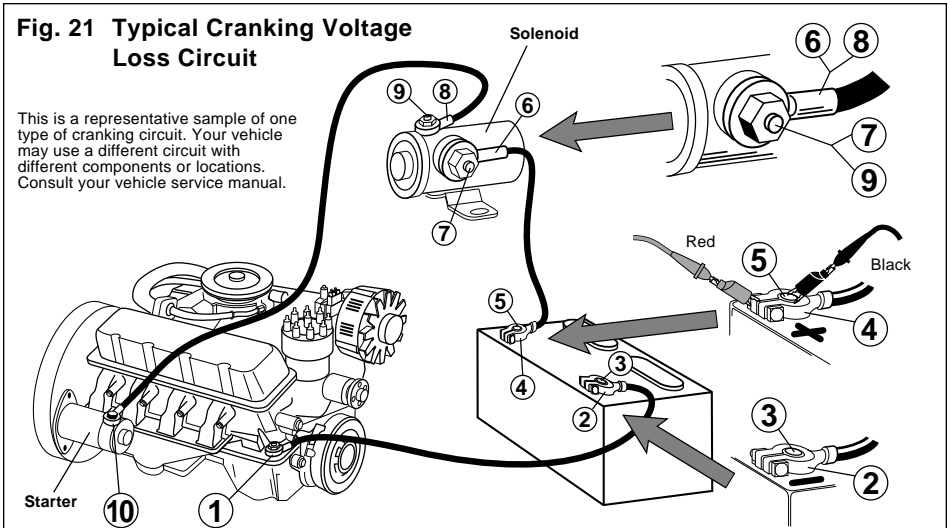

Charging System Voltage Test

This test checks the charging system to see if it charges the battery and provides power to the rest of the vehicles electrical systems (lights, fan, radio etc).

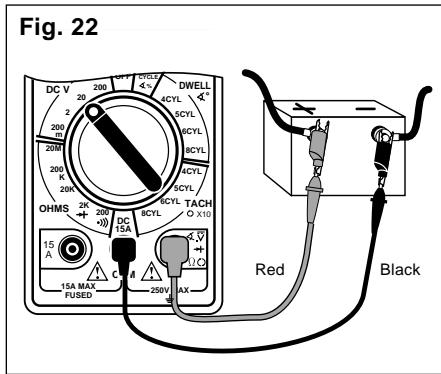

Fig. 22

Test Procedure (see Fig. 22):

1. Insert **BLACK** test lead into **COM** test lead jack.
2. Insert **RED** test lead into \overline{V} test lead jack.
3. Connect **RED** test lead to positive (+) terminal of battery.
4. Connect **BLACK** test lead to negative (-) terminal of battery.
5. Turn multimeter rotary switch to **20V DC** range.
6. **Start engine - Let idle.**

7. Turn off all accessories and view reading on display.

- Charging system is normal if display reads 13.2 to 15.2 volts.
- If display voltage is not between 13.2 to 15.2 volts, then proceed to Step 13.

8. Open throttle and Hold engine speed (RPM) between 1800 and 2800 RPM.

Hold this speed through Step 11 - Have an assistance help hold speed.

9. View reading on display.

Voltage reading should not change from Step 7 by more than 0.5V.

10. Load the electrical system by turning on the lights, windshield wipers, and setting the blower fan on high.

11. View reading on display.

Voltage should not drop down below about 13.0V.

12. Shut off all accessories, return engine to curb idle and shut off.

13. Test Results.

- If voltage readings in Steps 7, 9, and 11 were as expected, then charging system is normal.
- If any voltage readings in Steps 7, 9, and 11 were different then shown here or in vehicle service manual, then check for a loose alternator belt, defective regulator or alternator, poor connections, or open alternator field current.
- Refer to vehicle service manual for further diagnosis.

Ignition System Testing

The ignition system is responsible for providing the spark that ignites the fuel in the cylinder. Ignition system components that the digital multimeter can test are the primary and secondary ignition coil resistance, spark plug wire resistance, hall effect switches/sensors, reluctance pickup coil sensors, and the switching action of the primary ignition coil.

Ignition Coil Testing

This test measures the resistance of the primary and secondary of an ignition coil. This test can be used for distributorless ignition systems (DIS) provided the primary and secondary ignition coil terminals are easily accessible.

Test Procedure:

1. If engine is HOT let it COOL down before proceeding.
2. Disconnect ignition coil from ignition system.

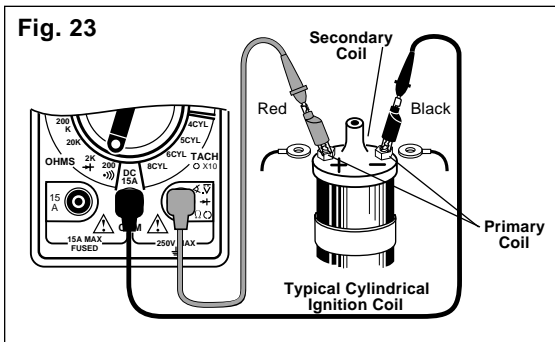

3. Insert BLACK test lead into COM test lead jack (see Fig. 23).
4. Insert RED test lead into Ω test lead jack.
5. Turn multimeter rotary switch to 200 Ω range.

6. Connect test leads.

- Connect RED test lead to primary ignition coil positive (+) terminal.
- Connect BLACK test lead to primary ignition coil negative (-) terminal.
- Refer to vehicle service manual for location of primary ignition coil terminals.

7. View reading on display.

Subtract test lead resistance found in Step 5 from above reading.

8. If vehicle is DIS, repeat Steps 6 and 7 for remaining ignition coils.

9. Test Results - Primary Coil

- Typical resistance range of primary ignition coils is 0.3 - 2.0 Ω .
- Refer to vehicle service manual for your vehicles resistance range.

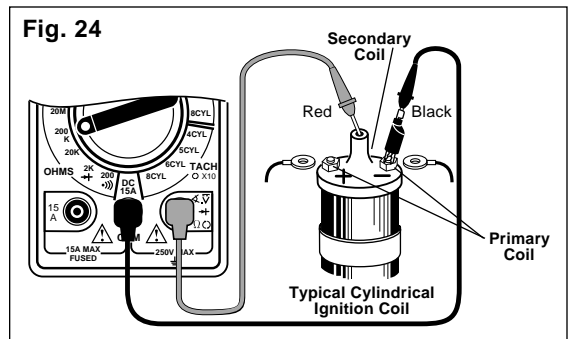

10. Turn multimeter rotary switch to 200K Ω range (see Fig. 24).

11. Move RED test lead to secondary ignition coil terminal.

- Refer to vehicle service manual for location of secondary ignition coil terminal.
- Verify BLACK test lead is connected to primary ignition coil negative (-) terminal.

12. View reading on display.

13. If vehicle is DIS, repeat Steps 11 and 12 for remaining ignition coils.

14. Test Results - Secondary Coil

- Typical resistance range of secondary ignition coils is 6.0 - 30.0K Ω .
- Refer to vehicle service manual for your vehicles resistance range.

15. Repeat test procedure for a HOT ignition coil.

NOTE: It is a good idea to test ignition coils when they are both hot and cold, because the resistance of the coil could change with temperature. This will also help in diagnosing intermittent ignition system problems.

16. Test Results - Overall

Good Ignition Coil: Resistance readings in Steps 9, 14 and 15 were within manufacturers specification.

Bad Ignition Coil: Resistance readings in Steps 9, 14 and 15 are not within manufacturers specification.

Hall Effect Sensors/Switches

Hall Effect sensors are used whenever the vehicle computer needs to know speed and position of a rotating object. Hall Effect sensors are commonly used in ignition systems to determine camshaft and crankshaft position so the vehicle computer knows the optimum time to fire the ignition coil(s) and turn on the fuel injectors. This test checks for proper operation of the Hall Effect sensor / switch.

Test Procedure (see Fig. 26):

1. Remove Hall Effect Sensor from vehicle.

Refer to vehicle service manual for procedure.

2. Connect 9V battery to sensor POWER and GROUND pins.

- Connect positive(+) terminal of 9V battery to sensor POWER pin.
- Connect negative(-) terminal of 9V battery to sensor GROUND pin.
- Refer to illustrations for POWER and GROUND pin locations.
- For sensors not illustrated refer to vehicle service manual for pin locations.

3. Insert BLACK test lead into COM test lead jack.

4. Insert RED test lead into Ω test lead jack.

5. Connect RED test lead to sensor SIGNAL pin.

6. Connect BLACK test lead to 9V battery negative(-) pin.

7. Turn multimeter rotary switch to 200 \gg function.

Multimeter should sound a tone.

8. Slide a flat blade of iron or magnetic steel between sensor and magnet. (Use a scrap of sheet metal, knife blade, steel ruler, etc.)

- Multimeter tone should stop and display should overrange.
- Remove steel blade and multimeter should again sound a tone.
- It is O.K. if display changes erratically after metal blade is removed.
- Repeat several times to verify results.

9. Test Results

Good Sensor: Multimeter toggles from tone to overrange as steel blade is inserted and removed.

Bad Sensor: No change in multimeter as steel blade is inserted and removed.

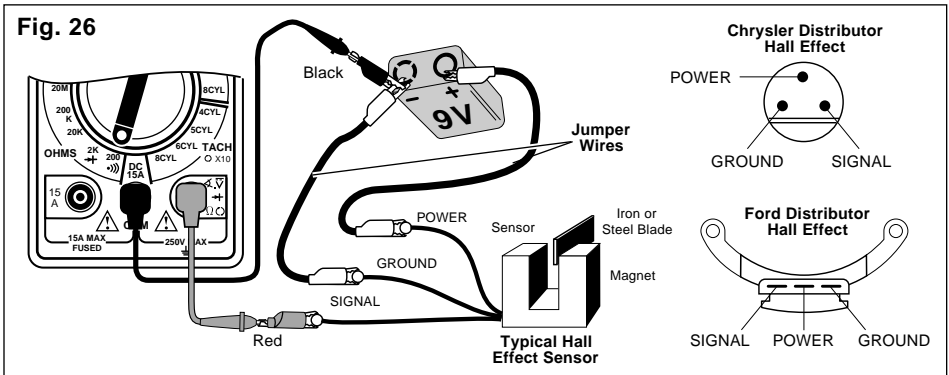

Magnetic Pick-Up Coils – Reluctance Sensors

Reluctance sensors are used whenever the vehicle computer needs to know speed and position of a rotating object. Reluctance sensors are commonly used in ignition systems to determine camshaft and crankshaft position so the vehicle computer knows the optimum time to fire the ignition coil(s) and turn on the fuel injectors. This test checks the reluctance sensor for an open or shorted coil. This test does not check the air gap or voltage output of the sensor.

3. Connect RED test lead to either sensor pin.
4. Connect BLACK test lead to remaining sensor pin.
5. Turn multimeter rotary switch to 2K Ω range.
6. View reading on display while flexing sensor wires in several places.
 - Typical resistance range is 150 - 1000 Ω .
 - Refer to vehicle service manual for your vehicles resistance range.
 - As you flex sensor wires, the display should remain steady.

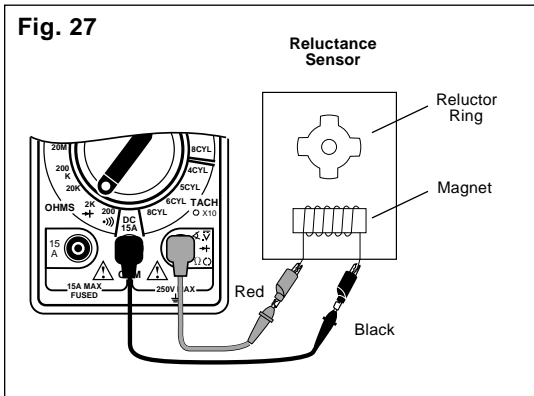

7. Test Results

Good Sensor: Display reading is within manufacturers specification and remains steady while sensor wires are flexed.

Bad Sensor: Display reading erratically changes as sensor wires are flexed or display reading is not within manufacturers specification.

Test Procedure (see Fig. 27):

1. Insert BLACK test lead into COM test lead jack.
2. Insert RED test lead into Ω test lead jack.

Ignition Coil Switching Action

This test checks to see if the negative terminal of the primary ignition coil is getting switched ON and OFF via the ignition module and camshaft / crankshaft position sensors. This switching action is where the RPM or tach signal originates. This test is primarily used for a **no start** condition.

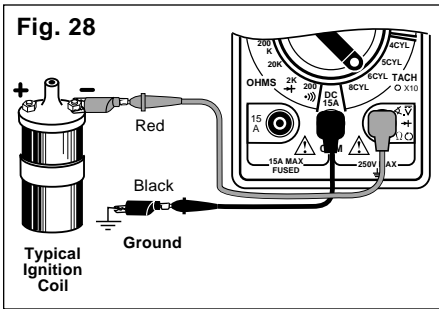

Test Procedure (see Fig. 28):

1. Insert **BLACK** test lead into **COM** test lead jack.
2. Insert **RED** test lead into $\text{V} \rightarrow \Omega \text{C}$ test lead jack.
3. Connect **RED** test lead to **TACH** signal wire.
 - If vehicle is DIS (Distributorless Ignition System), then connect RED test lead to the TACH signal wire going from the DIS

module to the vehicle engine computer. (refer to vehicle service manual for location of this wire)

- For all vehicles with distributors, connect RED test lead to negative side of primary ignition coil. (refer to vehicle service manual for location of ignition coil)

4. Connect **BLACK** test lead to a good vehicle ground.

5. Turn multimeter rotary switch to correct **CYLINDER** selection in **LO TACH**.

6. View reading on display while engine is cranking.

- Typical cranking RPM range is 50-275 RPM depending on temperature, size of engine, and battery condition.
- Refer to vehicle service manual for specific vehicle cranking RPM range.

7. **Test Results.**

Good Coil Switching Action: Display reading indicated a value consistent with manufacturers specifications.

Bad Coil Switching Action:

- Display read zero RPM, meaning the ignition coil is **not** being switched ON and OFF.
- Check ignition system for wiring defects, and test the camshaft and crankshaft sensors.

Fuel System Testing

The requirements for lower vehicle emissions has increased the need for more precise engine fuel control. Auto manufacturers began using electronically controlled carburetors in 1980 to meet emission requirements. Today's modern vehicles use electronic fuel injection to precisely control fuel and further lower emissions. The digital multimeter can be used to test the fuel mixture control solenoid on General Motors vehicles and to measure fuel injector resistance.

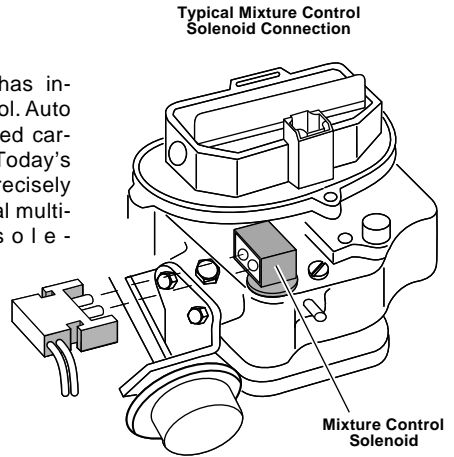

Testing GM C-3 Mixture Control Solenoid Dwell

This solenoid is located in the carburetor. Its purpose is to maintain an air/fuel ratio of 14.7 to 1 in order to reduce emissions. This test checks to see if the solenoid dwell is varying.

Test Description:

This test is rather long and detailed. Refer to vehicle service manual for the complete test procedure. Some important test procedure highlights you need to pay close attention to are listed below.

1. **Make sure engine is at operating temperature and running during test.**
2. **Refer to vehicle service manual for multimeter hook-up instructions.**
3. **Turn multimeter rotary switch to 6 Cylinder Dwell position for all GM vehicles.**
4. **Run engine at 3000 RPM.**
5. **Make engine run both RICH and LEAN.**
6. **Watch multimeter display.**
7. **Multimeter display should vary from 10° to 50° as vehicle changes from lean to rich.**

Measuring Fuel Injector Resistance

Fuel injectors are similar to solenoids. They contain a coil that is switched ON and OFF by the vehicle computer. This test measures the resistance of this coil to make sure it is not an open circuit. Shorted coils can also be detected if the specific manufacturer resistance of the fuel injector is known.

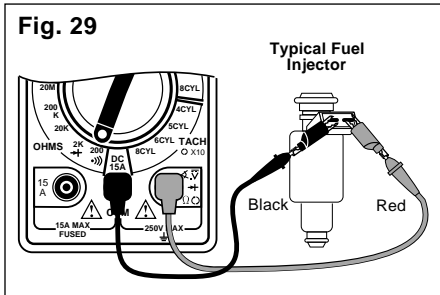

Fig. 29

Test Procedure (see Fig. 29):

1. Insert **BLACK** test lead into **COM** test lead jack.
2. Insert **RED** test lead into Ω test lead jack.
3. Turn multimeter rotary switch to **200Ω** range.

Touch RED and BLACK multimeter leads together and view reading on display.

Display should read typically 0.2 - 1.5Ω.

If display reading was greater than 1.5Ω, check both ends of test leads for bad connections. If bad connections are found, replace test leads.

4. **Disconnect wiring harness from fuel injector - Refer to vehicle service manual for procedure.**

5. **Connect RED and BLACK test leads across fuel injector pins.**

Make sure you connect test leads across fuel injector **and not** the wiring harness.

6. **Turn multimeter rotary switch to desired OHM range.**

If the approximate resistance is unknown, start at the largest OHM range and decrease to the appropriate range as required. (see Setting the Range on page 6)

7. **View reading on display - Note range setting for correct units.**

- If display reading is 10Ω or less, subtract test lead resistance found in Step 3 from above reading.
- Compare reading to manufacturers specifications for fuel injector coil resistance.
- This information is found in vehicle service manual.

8. Test Results

Good Fuel Injector resistance: Resistance of fuel injector coil is within manufacturers specifications.

Bad Fuel Injector resistance: Resistance of fuel injector coil is not within manufacturers specifications.

NOTE: If resistance of fuel injector coil is within manufacturers specifications, the fuel injector could still be defective. It is possible that the fuel injector is clogged or dirty and that is causing your driveability problem.

Testing Engine Sensors

In the early 1980's, computer controls were installed in vehicles to meet Federal Government regulations for lower emissions and better fuel economy. To do its job, a computer-controlled engine uses electronic sensors to find out what is happening in the engine. The job of the sensor is to take something the computer needs to know, such as engine temperature, and convert it to an electrical signal which the computer can understand. The digital multimeter is a useful tool for checking sensor operation.

Oxygen (O₂) Type Sensors

The Oxygen Sensor produces a voltage or resistance based on the amount of oxygen in the exhaust stream. A low voltage (high resistance) indicates a lean exhaust (too much oxygen), while a high voltage (low resistance) indicates a rich exhaust (not enough oxygen). The computer uses this voltage to adjust the air/fuel ratio. The two types of O₂ Sensors commonly in use are Zirconia and Titania. Refer to illustration for appearance differences of the two sensor types.

Test Procedure (see Fig. 30):

1. If engine is HOT, let it COOL down before proceeding.
2. Remove Oxygen Sensor from vehicle.
3. Insert BLACK test lead into COM test lead jack.
4. Insert RED test lead into $\nabla V \rightarrow \Omega \text{C}$ test lead jack.
5. Test heater circuit.
 - If sensor contains 3 or more wires, then your vehicle uses a heated O₂ sensor.
 - Refer to vehicle service manual for location of heater pins.
 - Connect RED test lead to either heater pin.

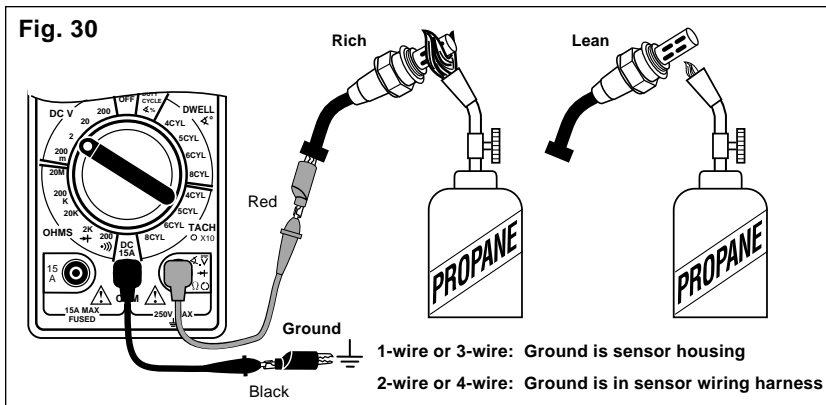
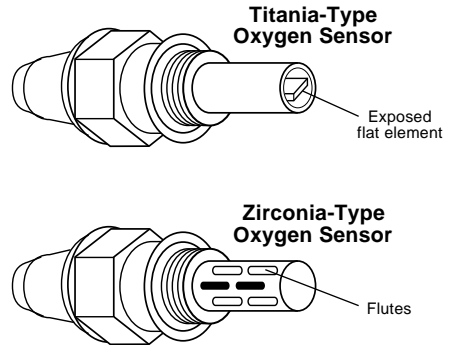

- Connect BLACK test lead to remaining heater pin.
 - Turn multimeter rotary switch to 200Ω range.
 - View reading on display.
 - Compare reading to manufacturer's specification in vehicle service manual.
 - Remove both test leads from sensor.
- 6. Connect BLACK test lead to sensor GROUND pin.**
- If sensor is 1-wire or 3-wire, then GROUND is sensor housing.
 - If sensor is 2-wire or 4-wire, then GROUND is in sensor wiring harness.
 - Refer to vehicle service manual for Oxygen Sensor wiring diagram.
- 7. Connect RED test lead to sensor SIGNAL pin.**
- 8. Test Oxygen Sensor.**
- Turn multimeter rotary switch to...
 - 2V range for Zirconia Type Sensors.
 - 200KΩ range for Titania Type Sensors.
 - Light propane torch.
 - Firmly grasp sensor with a pair of locking pliers.
 - Thoroughly heat sensor tip as hot as possible, but not “glowing.” Sensor tip must be at 660°F to operate.
 - Completely surround sensor tip with flame to deplete sensor of oxygen (Rich Condition).
- Multimeter display should read...
 - 0.6V or greater for Zirconia Type Sensors.
 - an Ohmic(Resistance) value for Titania Type Sensors. Reading will vary with flame temperature.
 - While still applying heat to sensor, move flame such that oxygen can reach sensor tip (Lean Condition).
 - Multimeter display should read...
 - 0.4V or less for Zirconia Type Sensors.
 - an overrange condition for Titania Type Sensors. (See Setting the Range on page 6.)
- 9. Repeat Step 8 a few times to verify results.**
- 10. Extinguish Flame, let sensor cool, and remove test leads.**
- 11. Test Results.**
- Good Sensor:*
- Heater Circuit resistance is within manufacturer's specification.
 - Oxygen Sensor output signal changed when exposed to a rich and lean condition.
- Bad Sensor:*
- Heater Circuit resistance is not within manufacturer's specification.
 - Oxygen Sensor output signal did not change when exposed to a rich and lean condition.
 - Oxygen sensor output voltage takes longer than 3 seconds to switch from a rich to a lean condition.

Temperature Type Sensors

A temperature sensor is a thermistor or a resistor whose resistance changes with temperature. The hotter the sensor gets, the lower the resistance becomes. Typical thermistor applications are engine coolant sensors, intake air temperature sensors, transmission fluid temperature sensors, and oil temperature sensors.

Test Procedure (see Fig. 31):

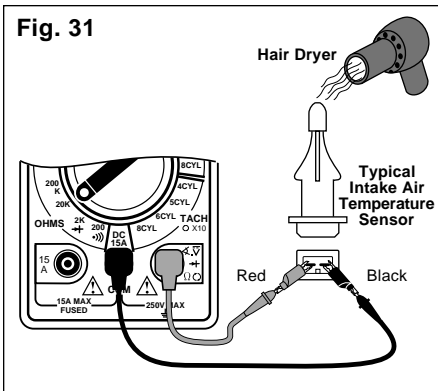

Fig. 31

1. If engine is HOT let it COOL down before proceeding.

Make sure all engine and transmission fluids are at outside air temperature before proceeding with this test!

2. Insert BLACK test lead into COM test lead jack.

3. Insert RED test lead into Ω test lead jack.

4. Disconnect wiring harness from sensor.

5. If testing Intake Air Temperature Sensor - Remove it from vehicle.

All other temperature sensors can remain on vehicle for testing.

6. Connect RED test lead to either sensor pin.

7. Connect BLACK test lead to remaining sensor pin.

8. Turn multimeter rotary switch to de-

sired OHM range.

If the approximate resistance is unknown, start at the largest OHM range and decrease to the appropriate range as required. (See Setting the Range on page 6)

9. View and record reading on display.

10. Disconnect multimeter test leads from sensor and reconnect sensor wiring.

This step does not apply to intake air temperature sensors. For intake air temperature sensors, leave multimeter test leads still connected to sensor.

11. Heat up sensor.

If testing Intake Air Temperature Sensor:

- To heat up sensor dip sensor tip into boiling water, or...
- Heat tip with a lighter if sensor tip is metal or a hair dryer if sensor tip is plastic.
- View and record smallest reading on display as sensor is heated.
- You may need to decrease the range to get a more accurate reading.

For all other temperature sensors:

- Start engine and let idle until upper radiator hose is warm.
- Turn ignition key OFF.
- Disconnect sensor wiring harness and reconnect multimeter test leads.
- View and record reading on display.

12. Test Results.

Good Sensor:

- Temperature sensors HOT resistance is at least 300Ω less than its COLD resistance.
- The key point is that the COLD resistance decreases with increasing temperature.

Bad Sensor:

- There is no change between the temperature sensors HOT resistance from the COLD resistance.
- The temperature sensor is an open or a short circuit.

Position Type Sensors

Position sensors are potentiometers or a type of variable resistor. They are used by the computer to determine position and direction of movement of a mechanical device. Typical position sensor applications are throttle position sensors, EGR valve position sensors, and vane air flow sensors.

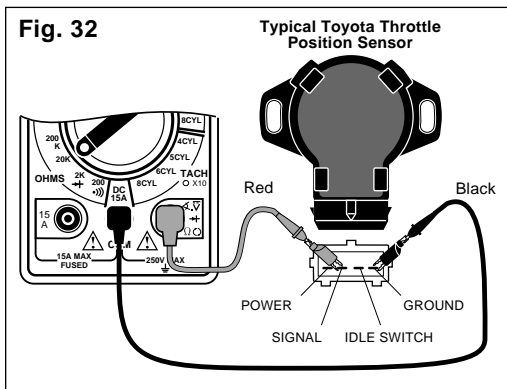

Test Procedure (see Fig. 32):

1. Insert **BLACK** test lead into **COM** test lead jack.
2. Insert **RED** test lead into Ω test lead jack.
3. Disconnect wiring harness from sensor.
4. Connect Test Leads.
 - Connect RED test lead to sensor POWER pin.
 - Connect BLACK test lead to sensor GROUND pin.
 - Refer to vehicle service manual for location of sensor POWER and GROUND pins.
5. Turn multimeter rotary switch to **20K Ω** range.
6. View and record reading on display.
 - Display should read some resistance value.
 - If multimeter is overranging, adjust the range accordingly. (See Setting the Range on page 6.)

- If multimeter overranges on largest range, then sensor is an open circuit and is defective.

7. Move RED test lead to sensor **SIGNAL** pin.

- Refer to vehicle service manual for location of sensor SIGNAL pin.

8. Operate Sensor.

Throttle Position Sensor:

- Slowly move throttle linkage from closed to wide open position.
- Depending on hook-up, the display reading will **either increase or decrease** in resistance.
- The display reading should **either start at or end at** the approximate resistance value measured in Step 6.
- Some throttle position sensors have an Idle or Wide Open Throttle (WOT) switch in addition to a potentiometer.

- To test these switches, follow the Testing Switches test procedure on page 13.
- When you are told to operate switch, then move throttle linkage.

Vane Air Flow Sensor:

- Slowly open vane “door” from closed to open by pushing on it with a pencil or similar object. This will not harm sensor.
- Depending on hook-up, the display reading will **either increase or decrease** in resistance.
- The display reading should **either start at or end at** the approximate resistance value measured in Step 6.
- Some vane air flow sensors have an idle switch and an intake air temperature sensor in addition to a potentiometer.
- To test idle switch see Testing Switches on page 13.
- When you are told to operate switch, then open vane “door”.
- To test intake air temperature sensor see Temperature Type Sensors on page 30.

EGR Valve Position

- Remove vacuum hose from EGR valve.
- Connect hand vacuum pump to EGR valve.
- Gradually apply vacuum to slowly open valve. (Typically, 5 to 10 in. of vacuum fully opens valve.)
- Depending on hook-up, the display reading will **either increase or decrease** in resistance.
- The display reading should **either start at or end at** the approximate resistance value measured in Step 6.

9. Test Results.

Good Sensor: Display reading gradually **increases or decreases** in resistance as sensor is opened and closed.

Bad Sensor: There is no change in resistance as sensor is opened or closed.

Manifold Absolute Pressure (MAP) and Barometric Pressure (BARO) Sensors

This sensor sends a signal to the computer indicating atmospheric pressure and/or engine vacuum. Depending on the type of MAP sensor, the signal may be a dc voltage or a frequency. GM, Chrysler, Honda and Toyota use a dc voltage MAP sensor, while Ford uses a frequency type. For other manufacturers refer to vehicle service manual for type of MAP sensor used.

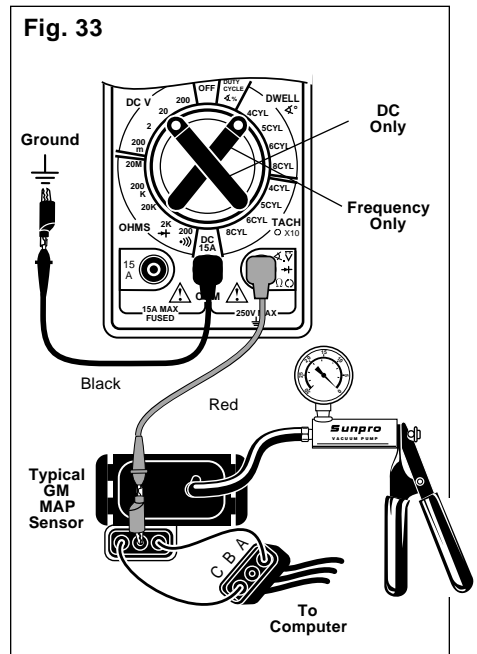

Test Procedure (see Fig. 33):

1. Insert **BLACK** test lead into **COM** test lead jack.
2. Insert **RED** test lead into..
 - $\text{V} \rightarrow \Omega$ test lead jack for DC type or low frequency type MAP sensors.

3. **Disconnect wiring harness and vacuum line from MAP sensor.**
4. **Connect jumper wire between Pin A on wiring harness and sensor.**
5. **Connect another jumper wire between Pin C on wiring harness and sensor.**
6. **Connect RED test lead to sensor Pin B.**
7. **Connect BLACK test lead to good vehicle ground.**
8. **Make sure test leads and jumper wires are not touching each other.**
9. **Connect a hand held vacuum pump to vacuum port on MAP sensor.**
10. **Turn Ignition Key ON, but do not start engine!**
11. **Turn multimeter rotary switch to...**
 - 20V range for DC type MAP sensors.
 - 4 Cylinder TACH position for Frequency type MAP sensors.

12. **View reading on display.**

DC Volts Type Sensor:

- Verify hand held vacuum pump is at 0 in. of vacuum.
- Display reading should be approximately 3V or 5V depending on MAP sensor manufacturer.

Frequency Type Sensor:

- Verify hand held vacuum pump is at 0 in. of vacuum.
- Display reading should be approximately 4770RPM \pm 5% for **Ford MAP sensors only**.
- For other frequency type MAP sensors refer to vehicle service manual for MAP sensor specifications.
- It is O.K. if last two display digits change slightly while vacuum is held constant.

- Remember to multiply display reading by 10 to get actual RPM.
- To convert RPM to Frequency or vice versa, use equation below.

$$\text{Frequency} = \frac{\text{RPM}}{30}$$

(Equation Only Valid for Multimeter in 4 Cylinder HI/LO TACH Position)

13. **Operate Sensor.**

- Slowly apply vacuum to MAP sensor - Never exceed 20 in. of vacuum because damage to MAP sensor may result.
- Display reading should decrease in voltage or RPM as vacuum to MAP sensor is increased.
- Refer to vehicle service manual for charts relating voltage and frequency drop to increasing engine vacuum.
- Use equation above for Frequency and RPM conversions.

14. **Test Results.**

Good Sensor:

- Sensor output voltage or frequency (RPM) are within manufacturers specifications at 0 in. of vacuum.
- Sensor output voltage or frequency (RPM) decrease with increasing vacuum.

Bad Sensor:

- Sensor output voltage or frequency (RPM) are not within manufacturers specifications at 0 in. of vacuum.
- Sensor output voltage or frequency (RPM) do not change with increasing vacuum.

Mass Air Flow (MAF) Sensors

This sensor sends a signal to the computer indicating the amount of air entering the engine. Depending on the sensor design, the signal may be a dc voltage, low frequency, or high frequency type. **The CP7678 can only test the dc voltage and low frequency type of MAF sensors.** The high frequency type sensors output a frequency that is too high for the CP7678 to measure. The high frequency type MAF is a 3-pin sensor used on 1989 and newer GM vehicles. Refer to vehicle service manual for the type of MAF sensor your vehicle uses.

Test Procedure (see Fig. 34):

1. Insert **BLACK** test lead into **COM** test lead jack.
2. Insert **RED** test lead into...
 - $\text{V} \rightarrow \Omega \text{C}$ test lead jack for **DC type or low frequency type MAF sensors.**

3. **Connect BLACK test lead to good vehicle ground.**
4. **Connect RED test lead to MAF signal wire.**
 - Refer to vehicle service manual for location of MAF signal wire.
 - You may have to backprobe or pierce MAF signal wire in order to make connection.
 - Refer to vehicle service manual for best way to connect to MAF signal wire.

5. **Turn Ignition Key ON, but do not start engine!**
6. **Turn multimeter rotary switch to...**
 - 20V range for DC type MAF sensors.
 - 4 Cylinder TACH position for Low Frequency type MAF sensors.
7. **View reading on display.**

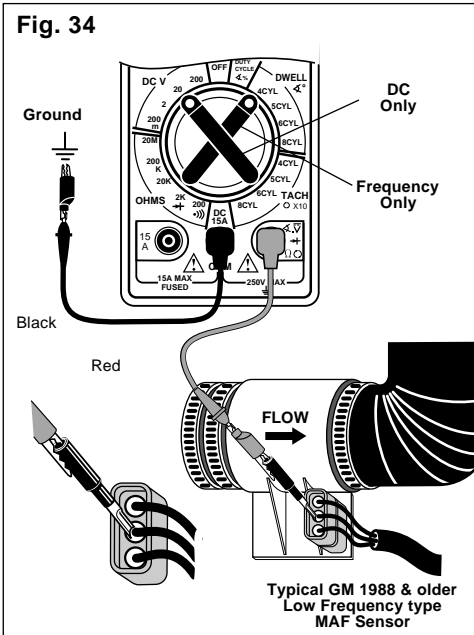

DC Volts Type Sensor:

- Display reading should be approximately 1V or less depending on MAF sensor manufacturer.

Low Frequency Type Sensor:

- Display reading should be approximately 330RPM \pm 5% for **GM Low Frequency MAF sensors.**
- For other Low Frequency type MAF sensors refer to vehicle service manual for MAF sensor specifications.
- It is O.K. if last two display digits change slightly while Key is ON.
- Remember to multiply display reading by 10 to get actual RPM.
- To convert RPM to Frequency or vice versa, use equation below.

$$\text{Frequency} = \frac{\text{RPM}}{30}$$

{Equation Only Valid for Multimeter in 4 Cylinder TACH Position}

8. **Operate Sensor.**

- Start engine and let idle.

- Display reading should...
 - increase in voltage from Key On Engine OFF for DC type MAF sensors.
 - increase in RPM from Key On Engine OFF for Low Frequency type MAF sensors.
- Rev Engine.
- Display reading should...
 - increase in voltage from Idle for DC type MAF sensors.
 - increase in RPM from Idle for Low Frequency type MAF sensors.
- Refer to vehicle service manual for charts relating MAF sensor voltage or frequency (RPM) to increasing air flow.
- Use equation above for Frequency and RPM conversions.

9. Test Results.

Good Sensor:

- Sensor output voltage or frequency (RPM) are within manufacturers specifications at Key ON Engine OFF.
- Sensor output voltage or frequency (RPM) increase with increasing air flow.

Bad Sensor:

- Sensor output voltage or frequency (RPM) are not within manufacturers specifications at Key ON Engine OFF.
- Sensor output voltage or frequency (RPM) do not change with increasing air flow.

FULL ONE (1) YEAR WARRANTY

Actron Manufacturing Company, 9999 Walford Avenue, Cleveland, Ohio 44102, warrants to the user that this unit will be free from defects in materials and workmanship for a period of one (1) year from the date of original purchase. Any unit that fails within this period will be repaired without charge when returned to the Factory. Actron requests that a copy of the original, dated sales receipt be returned with the unit to determine if the warranty period is still in effect. This warranty does not apply to damages caused by accident, alterations, or improper or unreasonable use. Expendable items, such as batteries, fuses, lamp bulbs, flash tubes also are excluded from the scope of this warranty. **ACTRON MANUFACTURING COMPANY DISCLAIMS ANY LIABILITY FOR INCIDENTAL OR CONSEQUENTIAL DAMAGES FOR BREACH OF ANY WRITTEN WARRANTY ON THE UNIT.** Some states do not allow the disclaimer of liability for incidental or consequential damages, so the above disclaimer may not apply to you. This warranty gives specific legal rights, and you may also have rights which vary from state to state.

The logo for Actron Manufacturing Co. features the word "actron" in a bold, lowercase, sans-serif font. To the right of the text are three slanted parallel bars, followed by a registered trademark symbol (®).

©1996, Actron Manufacturing Company

Sunpro is a registered trademark of Sun Electric Corporation and is used under exclusive license.

2-200102

Actron Manufacturing Co.
9999 Walford Avenue
Cleveland, Ohio 44102-4696