

DATSUN 280Z

1976

OWNER'S MANUAL
MODEL S30 SERIES





DISTRIBUTORS ADDRESSES IN YOUR COUNTRY

UNITED STATES Nissan Motor Corporation in U.S.A. NATIONAL HEADQUARTERS

1601 So. Fremont Street,
Covina, CA 91745 P.O. Box 105,
Sunnyvale, CA 95047
TEL: (415) 537-3111

REGIONAL OFFICES

BOSTON REGIONAL OFFICE Nissan Motor Corporation in U.S.A.

777 West Street, Needham,
Massachusetts 02468 P.O. Box 198,
Needham, Massachusetts 02468
TEL: (617) 339-3721

CHICAGO REGIONAL OFFICE Nissan Motor Corporation in U.S.A.

61 Steve Drive, Niles, IL 60521
P.O. Box 510, Niles, IL 60521
TEL: (312) 376-9290

DALLAS REGIONAL OFFICE Nissan Motor Corporation in U.S.A.

13423 So. Stemmons Freeway,
Dallas, Texas 75244 P.O. Box 44052,
Dallas, Texas 75294
TEL: (214) 243-4311

DENVER REGIONAL OFFICE Nissan Motor Corporation in U.S.A.

11000 East 46th Avenue, Denver,
Colorado 80238
TEL: (303) 371-4200

JACKSONVILLE REGIONAL OFFICE Nissan Motor Corporation in U.S.A.

8743 Walker Way, Jacksonville,
Florida 32217 P.O. Box 23029,
Jacksonville, Florida 32217
TEL: (904) 737-7100

LOS ANGELES REGIONAL OFFICE Nissan Motor Corporation in U.S.A.

137 East Alhambra Boulevard, Carlsbad,
San Diego, CA 92047 P.O. Box 290,
Santee, CA 92087
TEL: (619) 323-9900

NEW YORK REGIONAL OFFICE Nissan Motor Corporation in U.S.A.

Number 4 Corporate Place,
Piscataway, Near Jersey 08854
P.O. Box 342, Piscataway,
New Jersey 08854
TEL: (201) 961-0220

NORFOLK REGIONAL OFFICE Nissan Motor Corporation in U.S.A.

151 Harbor Drive, Portsmouth,
Virginia 23705 P.O. Box 1057,
Portsmouth, Virginia 23705
TEL: (804) 389-4011

PORTLAND REGIONAL OFFICE Nissan Motor Corporation in U.S.A.

9575 S.W. Scholls Ferry Road,
Portland, Oregon 97223 P.O. Box
22301, Portland, Oregon 97223
TEL: (503) 646-0243

SAN FRANCISCO REGIONAL OFFICE Nissan Motor Corporation in U.S.A.

460 Foster Boulevard, San
San Francisco, CA 94030
P.O. Box 2947, San Francisco,
CA 94030
TEL: (415) 873-6556

HAWAII Division of Hawaii, a Division of The Hawaii Corp.

711 Kapahulu Blvd., Honolulu,
Hawaii 96913
TEL: 501-3721

GUAM Nissan Motor Sales

P.O. Box 726, Agaña, Guam 96910
TEL: 777-6947, 8614, 8815, 8813

PUERTO RICO Nissan Motor, Inc.

P.O. Box 6-AD San Juan,
Puerto Rico 00930
TEL: 783-0315, 3378, 783-2374

SAMOA S.F. Kiesel, Inc.

Faga Faga, American Samoa
TEL: 3094

CANADA

HEAD OFFICE AND PACIFIC REGIONAL OFFICE

Nissan Automobile Co. (CANADA) Ltd.

480 Aulley Blvd., Annapolis Industrial
Estate, P.O. Box 2501, New Westminster,
British Columbia V3B 5A1
TEL: (604) 520-4520

PRAIRIE REGIONAL OFFICE

Nissan Automobile Co. (CANADA) Ltd.

1716 Barklark Crescent,
P.O. Box 1971
Calgary T2E 4B6, Alberta T2H 1Z6
TEL: (403) 253-7751

ONTARIO REGIONAL OFFICE

Nissan Automobile Co. (CANADA) Ltd.

177 Inverness Road, Concord,
Ontario, L4K 1S5
TEL: (416) 943-7230

QUEBEC REGIONAL OFFICE

Nissan Automobile Co. (CANADA) Ltd.

6710 Papez Gagnon Blvd.
Montreal 455, Quebec H3P 1Z2
TEL: (514) 375-3238

ATLANTIC REGIONAL OFFICE

Nissan Automobile Co. (CANADA) Ltd.

57 Wright Ave., P.O. Box 107
Dartmouth, Nova Scotia B3B 1H2
TEL: (902) 400-0020

A Word to Datsun Owners

Thank you for choosing a DATSUN. We are sure you will be happy you did. To make doubly sure, in this manual we have included driving tips, information about the location and purpose of dashboard instruments, comfort and safety features, and much more that will help you know your DATSUN.

Before your dealer delivers your DATSUN to you, he gives it a careful pre-delivery inspection, checking and servicing the mechanical parts to be sure your car is ready to drive. Return it to him for regular servicing. You will find a periodic maintenance and servicing schedule in this manual.

When you return your DATSUN to your dealer at the intervals our engineers recommend, you will gain the maximum wear-life from your car, and there will be far less likelihood of unpleasant road trouble.

Your dealer will validate your Guarantee and Service Booklet each time you bring your car in for periodic servicing. This satisfies the requirement that your car has been maintained at factory standards, if you need guarantee service. Keep the Guarantee and Service Booklet in your glove box at all times. It is important to you.

Your dealer uses genuine NISSAN parts, he has the equipment and experience to service your car, he is kept advised of every new technical development and—you are his customer. He wants to keep it that way. Your NISSAN/DATSUN dealership is the best place for you to take your car for any kind of service.

NISSAN MOTOR CO., LTD.

Contents

Economy Hints	2
Catalytic Converter System (For California)	3
Before Driving Your Datsun	4
Instrument and Controls	11
Starting and Operating	21
Comfort and Convenience Features	33
In Case of Emergency	44
Maintenance	47
Emission Control Systems	67
Specifications	86
Consumer Information	91
Index	100

This Owner's Manual has been prepared on the assumption that your car is fully equipped (including all optional equipment).

All information, specifications and illustrations in this manual are on a basis of the latest data obtainable at the time of the publication. Nissan reserves the right to make changes or improvements at any time without notice.

Economy Hints

Operational economy is one of the outstanding features of your DATSUN. However, by paying attention to the following points even greater economy will result.

1. Do not pump the accelerator. Gently depress until the desired speed has been attained and then, try to maintain that speed.
2. Always drive the car in the gear which properly suits the driving conditions.
3. Maintain moderate speeds on the highway. Speeds above 50 MPH (80 km/h) will considerably increase gasoline consumption.
4. Maintain a safe distance behind other cars. Avoid sudden stops. This will reduce wear on brake linings and pads and fuel as extra gasoline is required to accelerate back to driving speed.
5. Excessive engine idling increases gasoline consumption. If you are held up in traffic and are faced with a wait of more than a few minutes, switch off, conserve gasoline and start up again later.
6. Keep the tires at the recommended inflation pressures for longer tire life and fuel economy.
7. Keep your engine tuned-up and follow the recommended periodic maintenance schedule. This will increase the life of all parts and lower operating costs.
8. Check your tires regularly for abnormal wear. Out of alignment wheels cause the tires to drag resulting in premature tire wear and additional gasoline consumption.
9. Use the air conditioner only when necessary.

If you follow the guidelines enumerated above, you will attain remarkable savings.



Normal Driving - Saves Fuel and Money



Severe Driving - Wastes Fuel and Money

Catalytic Converter System (For California)

CATALYTIC CONVERTER SYSTEM (For California)

To meet the California emission standards, a catalytic converter system has been installed in all cars bound for California. The essential components of this system are the catalytic converter itself, a catalytic converter protective device and a floor temperature warning device. Using a platinum element as a catalyzer, the catalytic converter chemically converts the harmful carbon monoxide and hydrocarbon components of the exhaust into harmless carbon dioxide and water.



3Y027

Before Driving Your Datsun

Familiarize yourself with all the DATSUN features and safe-driving procedures described in this manual.

SAFETY CHECKS

Before driving your DATSUN, be sure to check all the safety items mentioned below.

– Before entering the car –

- Check that all windows and light lenses are clean.
- Visually inspect tires for condition. Also check tire inflation pressures.
- Check that area around car is clear before driving off.

– After entering the car –

- Lock all doors.
- Position seats.
- Fasten safety belts.
- Adjust inside and outside mirrors.
- Check the operation of lights, switches and horn.
- Check the operation of warning lights when key is turned to "ON" position.

~~~~~  
Fluid levels such as engine oil, engine coolant, brake and clutch fluid and windshield washer fluid should be checked daily and/or weekly, or whenever you refuel.

Further details are described in "Routine Service" under the heading "Maintenance".  
~~~~~

Before Driving Your Datsun

KEY

The key operates all the locks and the ignition switch on your DATSUN.

Reversible feature,
Either side up



DR484

- Ignition switch & steering lock
- Door locks
- Tail gate lock
- Glove compartment lock

Record the key number so your NISSAN/DATSUN dealer will be able to replace a lost key.

To prevent theft of your car, a warning buzzer will sound when the driver's door is opened if your key has been left in the ignition switch. Be sure to remove the key from the switch when leaving your car unattended.

DOOR LOCKS

From outside

To lock a door, insert the key and turn it toward the front of the car. To unlock, turn the key toward the rear.

The car is so designed that when the key is left inside, not all the doors can be locked, that is, the front doors can not be locked from the outside without a key.

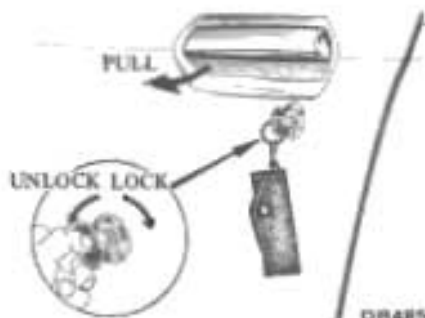

From inside

All doors can be locked from inside the car. When the door is locked, it cannot be opened by the inside door handle.

To lock a door, push the lock knob down. To unlock, pull up.

To prevent accidental opening of a door when driving, always lock doors from the inside, especially with small children in the car.

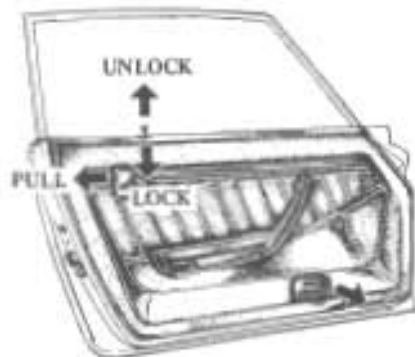

Before Driving Your Datsun

FUEL FILLER LID

The fuel filler lid is located on the right rear fender.

Notes:

- Do not forget to replace the filler cap after refilling.
- In California models, the fuel filler opening is designed to accept only an unleaded fuel gun [nozzle diameter less than 0.84 in (21.3 mm)] only.

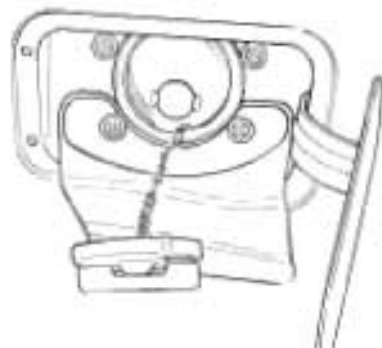

SEATS

Front seat adjustment

The fore-and-aft control lever located at the lower front of the seat releases the seat latch. To adjust the seat position, pull the lever upward, and hold it while you slide the seat forward or backward to the desired position. Release the lever to lock the seat in position.

Caution: Do not adjust the driver's seat while driving. The seat may suddenly jerk forward or backward, which could result in loss of control.



Reclining seat

The seat back control levers are located at the outside of each front seat. To adjust the seat back, pull the lever upward, and lean back until the desired angle is achieved. To bring the back up again, pull the lever and the back will move forward. When the seating angle is correct, release the lever.

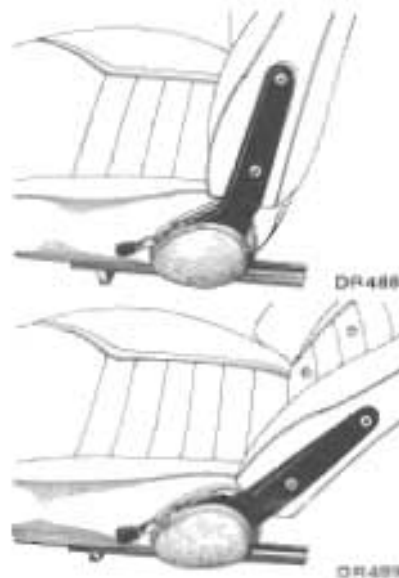

Tilting front seat (280Z 2+2 model)

The front seat back is easily tilted to get to the rear seat. Simply pull up the seat back control lever (same lever as reclining device) and the seat back will tilt forward.

SAFETY SEAT BELT

Front seat belt

1. Adjust the front seat to the most comfortable position and angle. (Take an erect posture position, and sit well back in the seat.)
2. Behind the seat cushion, along the lower edge of the door, is located the outer lap belt retractor. Place your hand on the belt tongue resting on the retractor cover.
3. Slowly, and in one motion, pull out the lap-shoulder belt until it reaches the inner lap belt buckle.

Note: If the pulling motion is interrupted while you are drawing out the belt, let the belt rewind into the retractor about one inch (25 mm) and the belt can be pulled out to the appropriate length.

4. Push the belt tongue into the buckle until you hear a snapping sound.

Note:

- Excess slack from both the shoulder and lap belts is automatically taken up by the belt retractor.

- Under normal circumstances the belt retractor permits the belt to move freely with the occupant, locking only in the event of an abrupt stop or impact.

Caution: Be sure to observe the following conditions. Failure to do so could increase the chance and/or severity of injury in an accident.

- Always pass the shoulder belt over your shoulder and across your chest. Never run the belt under your arm.
- Position the lap belt as low as possible **AROUND THE HIPS, NOT THE WAIST.**
- Never wear the belt inside out or twisted.
- Do not allow more than one person to use the same belt at the same time.

Comfort clip

After fastening the belt, pull out the shoulder belt to the extent that you have enough slack to place a fist between the belt and your chest. Then, slide the comfort clip toward the belt guide (shoulder belt retractor). This will eliminate any pressure on your chest or shoulder and allow you to move around comfortably.

Before Driving Your Datsun

Caution:

- Excessive slackness in the shoulder belt will reduce the effectiveness of the entire restraint system.
- For optimal restraint protection, use of the comfort clip is not recommended.



To unfasten belt

Press the button in the center of the buckle to unfasten the belt.

To prevent any hindrance when getting in or out of the car, the lap and shoulder belts can be stowed in their respective retractors. Slide the comfort clip down to allow the shoulder belt to rewind into the retractor.



DR456



DR457

Rear seat belt

1. Pull out the outboard lap belt until it reaches the buckle.
2. Insert the belt tongue into the buckle.

Caution:

- Position the belt as low as possible AROUND THE HIPS, NOT THE WAIST.
 - Never wear the belt inside out or twisted.
 - Do not allow more than one person to use the same belt at the same time.
3. Let the belt rewind into the retractor until it fits snugly across the hips.

Note: The belt retractor is designed not to lock the belt in a rewinding direction, but rather to lock it in an extending direction once it has been pulled out.

To release the stop mechanism, allow the belt to rewind all the way into the retractor and then pull it out again.



Seat belt maintenance

- To clean the belt webbings, apply a mild soap solution or any solution recommended for cleaning upholstery or carpet, brush it, wipe with cloth and allow it to dry in the shade.
- Do not allow the belts to retract until they are completely dry.
- Do not use any other chemicals or try bleaching or re-dyeing the belt, this may weaken the webbing.
- Periodically check the belt and metal components such as buckles, tongues, retractors, flexible wires and anchors for deterioration or damage.
- If any component is found deteriorated or damaged, the belt should be replaced as an assembly.

Before Driving Your Datsun

REARVIEW MIRRORS

Adjust the outside and inside mirrors before driving. For safe driving rear vision must be unimpaired.

Outside door mirror

The outside mirror can be moved in any direction for better rear view.

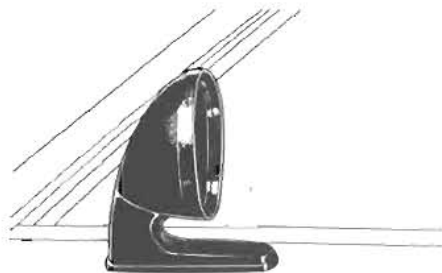

DR492

Inside day-night mirror

The inside rearview mirror is the glareproof day-night type.

To adjust the mirror turn the adjust knob to the sun (☀) mark for day driving and turn it 180° to the star (☆) mark for night driving.

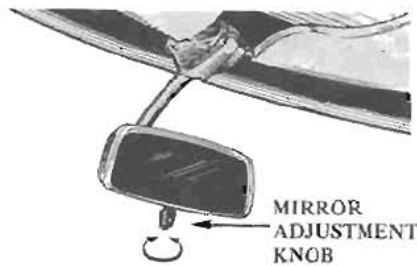

DR491

Instrument and Controls

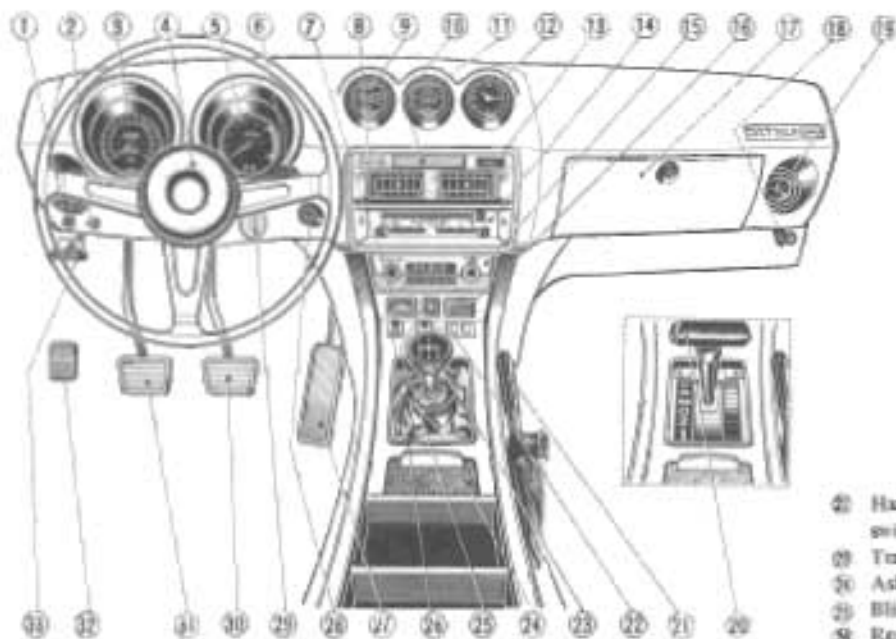

- ① Trip odometer reset control
- ② Illumination control
- ③ Speedometer
- ④ Horn pad
- ⑤ Tachometer
- ⑥ Light switch and wiper-washer switch
- ⑦ Rear defogger indicator light

- ⑧ Floor temperature warning light
- ⑨ Water temperature-oil pressure gauge
- ⑩ Map light
- ⑪ Voltmeter
- ⑫ Clock
- ⑬ Fuel warning light
- ⑭ Heater unit

- ⑮ Radio
- ⑯ Seat belt warning light
- ⑰ Glove box
- ⑱ Dash side ventilator knob
- ⑳ Side ventilator
- ㉑ Transmission select lever (Automatic transmission)
- ㉒ Parking brake lever

- IN525
- ㉓ Hazard warning flasher switch
 - ㉔ Transmission control lever
 - ㉕ Ash tray
 - ㉖ Blind plug
 - ㉗ Rear window electric defroster switch
 - ㉘ Accelerator pedal
 - ㉙ Cigarette lighter
 - ㉚ Ignition switch and steering lock
 - ㉛ Brake pedal
 - ㉜ Clutch pedal
 - ㉝ Foot rest
 - ㉞ Hood release handle

Instrument and Controls

SPEEDOMETER

The speedometer indicates running speed in miles per hour (in miles and kilometers per hour for Canada). The odometer records the total mileage your car has been driven and is useful for keeping a record of maintenance intervals. The trip odometer records the mileage of an individual journey after resetting. The last digit in yellow indicates 1/10 of a mile. Reset the trip odometer to zero by turning the reset knob clockwise.

HEADLIGHT BEAM INDICATOR LIGHT TRIP ODOMETER



For Canada

HEADLIGHT BEAM INDICATOR LIGHT TRIP ODOMETER

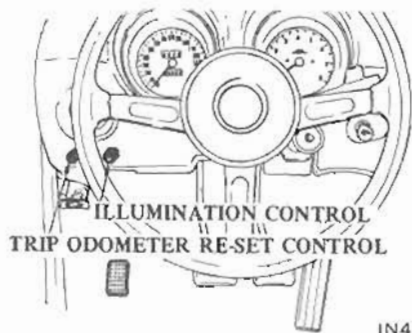

TACHOMETER

The electrically operated tachometer indicates the engine speed calibrated in thousands of revolutions per minute (rpm).

There are two different colored zones on its face.

Never drive in the red zone.



TURN SIGNAL INDICATOR LIGHTS

FUEL GAUGE

When the ignition switch is "ON", the fuel gauge registers the fuel level in the tank. The position of the needle will vary slightly when accelerating, braking, or when the car is going up or down hill. So check your fuel supply when the car is more or less level, whether standing still or moving.

WATER TEMPERATURE GAUGE

When the ignition switch is set to "ON", the water temperature gauge operates and the pointer indicates coolant temperature in the range from 120 to 248°F (49 to 120°C).

During ordinary driving, the pointer will indicate 171 to 219°F (77 to 104°C).

If the pointer indicates over 239°F (115°C), and remains there for more than a minute or two, stop the car and cool the engine while keeping the engine speed at 1,000 to 1,500 rpm. Then check the coolant level.

OIL PRESSURE GAUGE

The oil pressure gauge indicates the pressure of the oil in the engine.

Note: In cold weather, the engine oil pressure will increase slightly until the engine has reached its normal operating temperature.

VOLTMETER

The voltmeter monitors the condition of the charging system and the state of charge of the battery, as outlined below:

- Before starting the engine, check the position of the needle.

If the needle is in either the YELLOW or RED zone.
. Check the condition of the battery.

- During starter operation

If the needle is in the RED zone, the condition is normal.

Note: After starter operation, the needle may sometimes stay within a range of 6 to 8 volts, even though nothing is wrong with the battery or charging system.

The needle will fall back as the battery is discharged.

- While the engine is idling or the car is being driven and the needle is in the uncolored zone, the condition is normal.

If the needle is in the YELLOW zone. Check the following as necessary:

- Loose fan belt
- Condition of battery and voltage regulator
- Electrical overload

If the needle is in the RED zone Be sure to check the following:

- Loose fan belt
- Condition of battery and voltage regulator
- Electrical overload

Instrument and Controls



IN518

CHARGE WARNING LIGHT

The condition of the alternator system of your car is continuously monitored by this light. It will quickly warn you of any malfunction. When the ignition switch is in the "ON" position, before the engine is started, the light should be on. After the engine is started, the light should turn off and remain off while the engine is running. If it remains on, the car should be taken to an authorized NISSAN/DATSUN dealer or any other qualified service outlet as soon as possible.

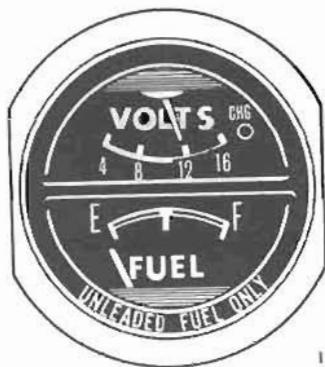

IN522

FUEL WARNING LIGHT

With the ignition switch "ON", the fuel warning light comes on when the fuel in the fuel tank drops below 2 $\frac{3}{8}$ US gal (2 $\frac{1}{4}$ Imp gal, 10 liters). When the fuel warning lamp comes on, refuel at the nearest gas station.

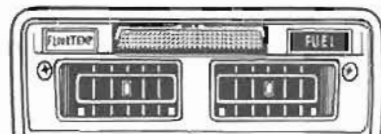

IN521

BRAKE WARNING LIGHT

The foot brake system is designed with a dual circuit, one circuit controlling the front wheels and the other the rear wheels. When the brake pedal is depressed, both circuits operate simultaneously, but each circuit is independent of the other – if one circuit should fail, the other will continue to operate. To check the operation of the dual circuit system, turn the ignition switch to “ON” and depress the brake pedal. The brake warning light should not glow. If it does glow, only one circuit is operating. Have your brakes repaired immediately. Only if it is safe should you drive your car, at reduced speed, to the nearest service station.

The same warning light is also used as the parking brake warning light. With the ignition switch turned “ON”, apply the parking brake. The light should glow. If it does not glow, check for a burned out bulb or a broken wire.

PARKING BRAKE WARNING LIGHT

With the ignition switch turned on, the parking brake warning light glows whenever the parking brake is applied.

The light will go out when the parking brake is released. If the light does not glow when the parking brake is applied, check the electrical system for a burned out bulb or an open circuit.

Instrument and Controls **HIGH BEAM INDICATOR LIGHT**

The headlights have two beams to meet varying night driving conditions. The high beams give better long range visibility. With the headlights on, the beam indicator shows blue whenever the high beams are used, and goes off when the low beams are selected.

TURN SIGNAL INDICATOR LIGHTS

The green indicator light on the instrument panel flashes simultaneously with the exterior turn signal lights.

Instrument and Controls

SEAT BELT WARNING LIGHT AND BUZZER

The front seats are equipped with a seat belt warning light and buzzer system.

Except Canada

The seat belt warning light "FASTEN SEAT BELTS" comes on for about six seconds whenever the ignition switch is placed in the "START" position.

The seat belt warning buzzer will sound for about six seconds when starting the engine if you do not fasten the front seat belts securely.

For Canada

If the warning buzzer and the "FASTEN SEAT BELTS" warning light are actuated when the ignition switch is placed in the "ON" position, recheck to ensure that each seat belt is fastened securely.



1N520

FLOOR TEMPERATURE WARNING LIGHT (For California)

If, while the engine is running, the floor temperature rises to an abnormal level, this warning light will come on to tell the driver that the engine is malfunctioning or operating under severe strain. For details, refer to the "Starting and Operating" section.

FLOOR TEMPERATURE WARNING LIGHT

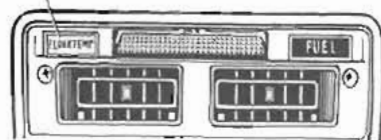

1N521

LIGHT SWITCH

The light switch controls parking lights, headlights, taillights, license plate light, side marker lights and instrument panel lights (and — on cars with automatic transmission — the light for the selector lever indicator).

With the light switch knob turned on, the following lights will be lit.

1st position:

Parking, tail, license, side marker, automatic transmission selector lever indicator and instrument panel lights

2nd position:

Headlights and all the above lights
(The headlight beams are controlled by the turn signal lever.)



IN407

TURN SIGNAL SWITCH

To signal a right turn, push the turn signal switch lever upward.

For a left turn signal, push the lever downward.

With the lever at either position, lights flash on the front and rear of the car, indicating the direction you are about to turn.

A corresponding turn signal indicator light on the instrument panel tells you which set of signals —right or left— is operating.

The turn signals cancel automatically when you have completed a turn, and the steering wheel has returned to the straight ahead position.

Occasionally the turn may be so wide and gradual that the steering wheel will not rotate far enough to cancel the turn indicator.

If this happens, just flick the lever to neutral position.

Turn signal switch lever (Headlight)

The turn signal switch lever also controls headlight high/low beam when the light switch is turned to the 2nd position.

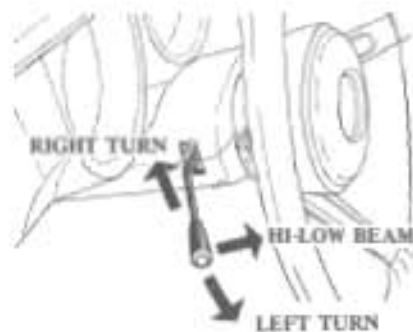

IN408

Instrument and Controls

ILLUMINATION CONTROL RHEOSTAT

The illumination control rheostat is located on the instrument panel. The brightness of all gauges and instrumentation lights can be adjusted by turning the control knob.

Turning the knob clockwise will brighten the illumination lights. To turn off the illumination lights, turn the knob counterclockwise all the way.

When the light switch is turned on, the rheostat control will be activated.

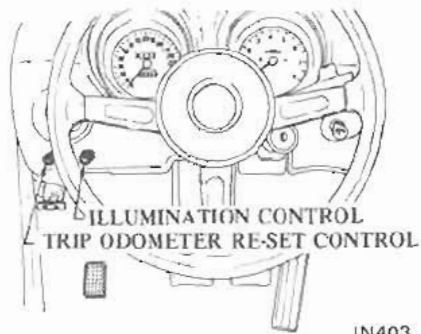

WINDSHIELD WIPER AND WASHER SWITCH

The windshield wiper has three speed positions.

The first position is for low speed and the second is for high speed. And in the third position wiper blades operate intermittently.

The wiper switch also controls the windshield washer. To operate the washer, depress the button located at the end of the lever until there is enough fluid on the windshield to wash off dirt.



Notes:

- Check washer fluid level regularly.
- Do not operate the washer continuously more than thirty seconds.
- In cold weather, defrost the windshield glass before operating the washer.
- Do not substitute radiator anti-freeze for windshield washer solutions.
- Do not wipe the glass with a dry cloth. It may scratch the glass.
- Do not operate washer if reservoir is dry.

Instrument and Controls

HORN

Sound the horn by depressing the horn button in the center of the steering wheel.



IN411

HAZARD WARNING FLASHER SWITCH

By pushing the rocker switch, all the directional lights flash at the same time.

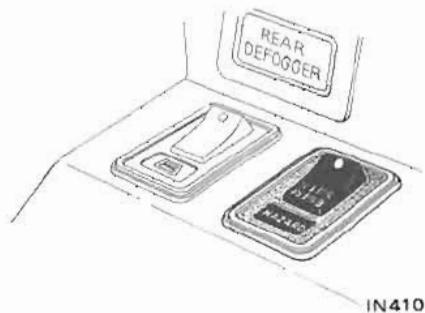

IN410

REAR WINDOW ELECTRIC DEFROSTER SWITCH

An electric defroster is built into the rear window.

To heat the rear window glass, move the switch to the "ON" position.

A light installed in the switch will glow to indicate the system is on. When the window is clear, turn the switch off.

The switch operates only when the ignition switch is in the "ON" or "ACC" position.

Caution: When you clean the car, do not clean the inner side of the window with abrasive-type cleaners, and do not use any type of scraper to remove foreign deposits from the inner glass surface as this may cause damage to the electrical conductors.

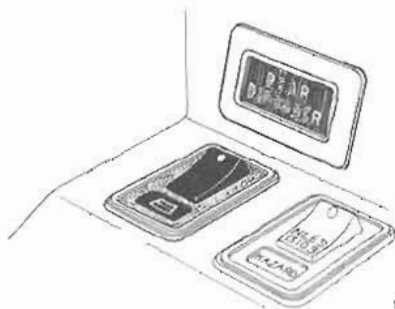

IN413

Notes:

- Avoid stopping on the roadway if possible.
- When stalled or stopped under emergency conditions, move the car well off the road.
- Do not use the switch while moving on the highway unless unusual circumstances force you to drive so slowly that your car might become a hazard to other traffic.

Instrument and Controls

PARKING BRAKE LEVER

To set the parking brake, pull the lever upwards. It is a good practice to depress the foot brake pedal at the same time.

To release, pull upward. Then depress the push-button and push down all the way.

If the ignition switch is "ON", the brake warning light will glow as long as the parking brake is engaged.

Caution: If you drive a car with the parking brake partially engaged, the rear brake shoes may be damaged.

Make sure that the parking brake is completely released before driving.

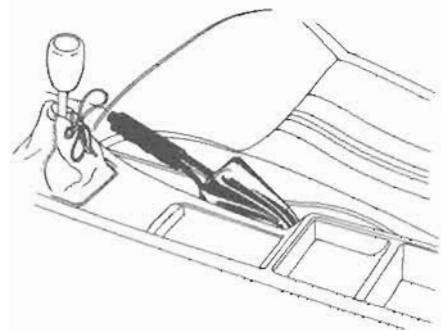

DASH SIDE VENTILATOR KNOB

Fresh outside air is introduced into the passenger compartment by pulling the dash side ventilator knob.

The dash side ventilator with the knob is located only at the right side of the instrument panel.

The dash side ventilator opens when the knob is pulled out and closes when it is pushed in.

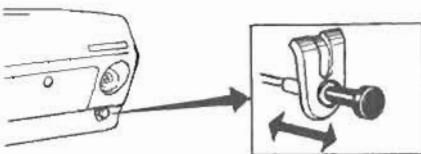

CM472

BREAK-IN SCHEDULE

All new cars require careful driving during the break-in period. Pistons, cylinder walls, and bearings must have time to seat properly and produce smooth, long wearing surfaces. Too much strain on a new engine impedes this gradual break-in process and is likely to shorten engine life.

During the first 1,000 miles (1,600 km) do not drive at full throttle, or exceed the upper speed limit except for brief periods. However, the engine should not be allowed to labor before downshifting when climbing a hill. Variable speeds are best during the break-in period. Always drive so that the engine runs fast enough to prevent strain.

Fuel economy will vary in the first few thousand miles (kilometers) of operation due to engine break-in. Also it is dependent upon driving and proper maintenance. Therefore to conserve fuel and assist the break-in:

- Do not drive at high speeds before the engine has sufficiently warmed up.
- Avoid fast starts.
- Do not allow the engine to labor in any gear.
- Avoid driving at full throttle for the first 1,000 miles (1,600 km).
- Do not race the engine.
- Avoid extended idling periods.
- Except in an emergency, avoid heavy braking or rough usage of the brakes. This will allow the brakes to seat properly.

Break-in speed limit MPH (km/h)

	1st	2nd	3rd	4th
Manual transmission	0 to 25 (0 to 40)	15 to 40 (25 to 65)	22 to 65 (35 to 105)	30 to 90 (50 to 145)
Automatic transmission	"1" Low	"2" Second	"D" Drive	
	30 (50)	55 (90)	80 (130)	

Starting and Operating THE CAR EQUIPPED WITH CATALYTIC CONVERTER (For California)

On all California models a catalytic converter for emission control is installed along the exhaust pipe. Inside this converter, exhaust gases are burned at high temperatures to remove harmful exhaust gas components.

Note: If the engine is kept running at high speeds when continuous misfiring occurs, the temperature of the exhaust system components and exhaust gases will become excessively high.

As a safety factor, a warning light device is installed.

Caution:

- Keep an eye on your fuel gauge; running out of gas could possibly cause damage to the catalytic converter.
 - Refrain from racing the engine.
 - Do not stop or park the car over inflammable materials, such as dry grass, waste paper, or rags that may come into contact with the exhaust system.
 - When parking, ensure that people or inflammable materials are kept approximately one foot away from the exhaust pipe.
-

Floor temperature warning light

- * When the ignition switch is turned to the "START" position, the light comes on.
- * If while the engine is running, the floor temperature rises to an abnormal level, this warning light will come on.
- * It will go out when the floor temperature returns to normal.

Starting and Operating

STARTING THE ENGINE

Warning:

Never inhale exhaust gases; they contain carbon monoxide, a colorless, odorless extremely dangerous gas which can cause death. If you should suspect that exhaust fumes are getting into the passenger compartment, have the car examined and the leakage corrected immediately.

1. It is not advisable to sit for any length of time in a parked car with the engine running.
2. Do not run the engine in closed spaces such as a garage for any longer than is absolutely necessary.
3. When a car has been stopped in an open area with its engine running for any significant length of time, turn the ventilator on so as to force outside air into the car.
4. If the tailgate is not closed while driving, exhaust gases could be inadvertently drawn into the car. Thus avoid driving at high speeds for great lengths of time with the tailgate open.

- When the warning light comes on —
- * If the light should come on while the car is being driven, reduce the speed immediately. After the light goes out return to normal driving speed.
 - * If this warning light should start to come on frequently, or if you should notice unusual power loss or abnormal engine vibration, stop the engine. Then check the spark plug wires of the engine. If any of them are disconnected, reconnect them correctly.

- * If the spark plug wires are properly connected, have the car inspected by an authorized NISSAN/DATSUN dealer or other competent service facility.

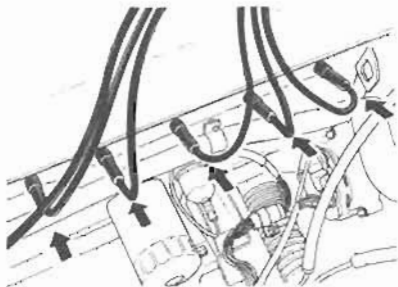

IN560

Starting and Operating

5. Always maintain the front ventilator inlet grille free from snow, leaves or any other kinds of obstructions so that the car's ventilation system will be able to function properly at all times.

Ignition switch

The 5-position ignition switch is located on the right side of the steering column. The switch includes the anti-theft steering lock device and also controls the ignition system and most of the electrical equipment:

"LOCK" Normal parking position

The ignition key can be inserted and removed at the "LOCK" position only. The steering can be locked by turning the key to the "LOCK" position, removing it, and rotating the steering wheel until the locking plunger clicks into position.

To unlock the steering, insert the key and turn it to the "OFF" position. For easier key operation when unlocking, rotate the steering wheel slightly to relieve pressure on the steering lock.

"OFF"

This position permits turning the engine off without locking the steering wheel.

"ACC" (Accessories)

This position allows you to use all the electrical accessories controlled by the switch.

"ON" Normal operating position

This position turns on the ignition system and electrical circuits.

"START"

This position starts the engine. After the engine has started, release the key. It will automatically return to the "ON" position.

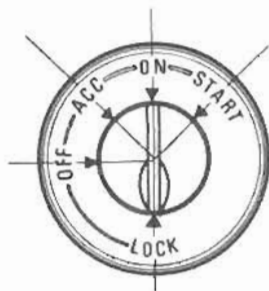

IN389

Parking

Before leaving your car:

1. Set the parking brake.
2. Place the gearshift lever in the “Reverse” (or, on the automatic transmission model, into the “P” position).

Note: When parking on an uphill grade in the manual transmission model, place the gearshift lever in the “1st” position.

3. Turn the ignition key to the “LOCK” position.
4. Remove the ignition key.
5. Lock all doors.

Before starting the engine:

1. After each person is seated, close and lock doors.
2. Fasten the driver’s seat belt and passenger’s seat belt (if occupied).
3. Make sure the parking brake is “ON”.
4. Place the gearshift lever into “NEUTRAL” (in “N” or “P” position for the automatic transmission).
5. With a manual transmission, depress the clutch pedal to reduce drag from transmission gears.
6. Turn the ignition key to the “ON” position.
7. Start the engine in the normal manner.

Notes:

- Except Canada:
The “FASTEN SEAT BELTS” warning light comes on for about six seconds when the ignition switch is placed in the “START” position. If the warning buzzer sounds for about six seconds when the switch is in the “START” position, recheck to ensure that each seat belt is fastened securely.
- For Canada:
If the warning buzzer and the “FASTEN SEAT BELTS” warning light are actuated when the ignition switch is placed in the “ON” position, recheck to ensure that each seat belt is fastened securely.

Starting and Operating

Tips on starting

- To start the engine, turn on the ignition switch without depressing the accelerator pedal.

Note: If the engine is very hard to start in extremely cold or hot weather, use the accelerator pedal to help starting the engine.

When the engine starts running under its own power, release the key and it will spring back to the "ON" position automatically.

If the engine fails to run, repeat the above procedure.

Note: It is also advisable for manual transmission model to depress the clutch pedal especially on cold mornings, to reduce the drag from the transmission gears.

- Warm-up

Always allow the engine to idle for at least 30 seconds after starting and drive at moderate speeds for a short distance, especially in cold weather.

- If it becomes necessary to start the engine with a booster battery and jumper cables, the booster battery voltage must not exceed 12 volts, or the control unit of the fuel injection system and other electronic components will be damaged.

DRIVING WITH MANUAL TRANSMISSION

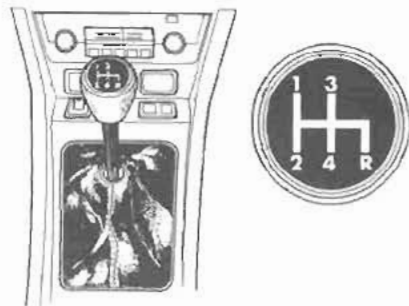

Your car has a 4-forward and 1-reverse speed transmission. The shift pattern diagram is shown in the figure(s) above.

Before starting the engine, make sure that the gearshift lever is in "N" (Neutral) position.

To start the car moving, first depress the clutch pedal fully and shift the gearshift lever from "N" (Neutral) to "1" (Low gear). Then release the clutch pedal gradually with the accelerator pedal slightly depressed.

Starting and Operating DRIVING WITH AUTOMATIC TRANSMISSION

Accelerate until the car reaches enough speed to upshift into "2" (Second gear). With the clutch pedal fully depressed, shift into "2" (Second gear), release the clutch pedal and accelerate.

Shift from second to third and to fourth in the following prescribed speed ranges, in the same manner as shifting into "2".

To stop the car, release the accelerator pedal and press the brake pedal until the car slows down to 10 to 15 MPH. Then depress the clutch pedal, continuing to brake until the car stops completely.

Notes:

1. When you are shifting from one gear to another, be sure that you depress the clutch pedal all the way to the floor to avoid clashing and chipping the transmission gears.
2. Shift into reverse gear only after the car has completely stopped.
3. Do not rest your foot on the clutch pedal except when you are ready to shift gears. Using the clutch pedal as a footrest may result in clutch damage.

4. Never slip the clutch by releasing the pedal just enough to hold the car at a standstill on a steep hill.
5. When climbing steep grades, downshift into a lower gear before the engine starts to labor.

To maintain safe speeds on steep downgrades and to help save brakes, shift to a lower gear before you start down.

6. When quick acceleration is required, shift to a lower gear and accelerate until the car reaches maximum speed in each gear. Do not exceed the speed limit of any gear.
7. In normal acceleration, it is most economical to change gears at the lower end of the speed ranges prescribed.

Appropriate speed range in each gear

MPH (km/h)

1st	0 to 38 (0 to 60)
2nd	15 to 60 (25 to 95)
3rd	22 to 95 (35 to 153)
4th	Over 30 (50)

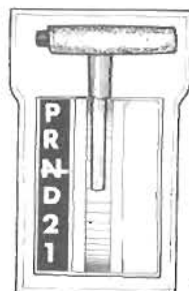

OP070

Push in button to shift into P, R, or 2.

Cars equipped with an automatic transmission have two pedals, one for braking and the other for accelerating. The automatic transmission eliminates the clutch pedal, providing fully automatic operation for selecting and shifting gears.

Starting and Operating

How to operate selector lever

Push the button located on the end of the selector lever when engaging “R” and “P” and when shifting from “D” to “2”.

The lever can be shifted freely into any other position.

Notes:

- Start the engine in the “P” or “N” position.
- Always apply the parking brake or foot brake before shifting into any driving position. This prevents the car from creeping.
- Keep the engine at idling speed while shifting from “N” to any driving position.
- Do not accelerate to keep the car halted on a steep hill.

“P” Parking:

After parking the car, apply the parking brake and set the selector lever in the “P” position. This position locks the transmission and rear wheels. Do not shift into “P” while the car is moving.

“R” Reverse:

Shift into the “R” position only after the car has completely stopped. Then gently depress the accelerator pedal to back up.

“N” Neutral:

In the “N” position neither forward or reverse gear is engaged.

“D” Normal drive position:

This position is used for most city and highway driving. Press the accelerator pedal slowly to start the car and increase car speed. The 3-forward gears are up-shifted automatically from low to second and to third. When speed decreases, downshifting is also automatic.

“2” Second gear:

Use the “2” position when starting on slippery roads or ascending hills and for effective engine braking on downhill grades.

Do not downshift into the “2” position at speeds over 70 MPH (113 km/h). Do not exceed 70 MPH (113 km/h) in the “2” position.

“1” Low gear:

The “1” low gear is helpful for driving up very steep hills and for braking the car on downhill grades. When downshifting into the “1” position, move the selector lever from “D” to “2” and then to “1”.

Even if the selector lever is downshifted into “1”, the car remains in second gear until the car speed drops below 30 MPH (50 km/h). **Do not shift into the “1” position at speeds over 70 MPH (113 km/h). Do not exceed 45 MPH (70 km/h) in the “1” position.**

Accelerator downshift – In drive–

You can get extra power and acceleration for rapid passing or hill climbing by flooring the accelerator pedal to downshift the gears. The accelerator downshift makes the transmission downshift into second gear when driving below 60 MPH (95 km/h) and into low gear when driving below 30 MPH (50 km/h).

TIPS ON DRIVING

Driving uphill

When starting on a steep grade it is sometimes difficult to operate the brake and clutch. The operation of the parking brake, clutch pedal and accelerator pedal is very important.

The engine brake is the most effective for descending hills. The gearshift lever should be placed in the lower speed position prior to descending. With the automatic transmission car, the "2" or "1" position should be selected.

Wet brakes

After washing the car or when driving under extremely wet conditions, the brake linings sometimes get wet. Gently apply the brakes several times as the car is moving slowly to dry the linings. Do not drive the car at high speeds until the brakes are functioning correctly.

Spark plugs

The factory-installed spark plugs on your car are designed to meet normal driving conditions. If your car is operated under either of the following conditions, it is recommended that optional spark plugs of the proper heat range be installed.

1. When the car is used primarily for short distance travel, so that the engine does not run long enough to reach its normal operating temperature, use hot-type spark plugs.
2. When the car is frequently operated with throttle wide open for long periods of time, use cold-type spark plugs.

Recommended spark plugs

Hot type	Standard type	Cold type
B5ES	B6ES	B7ES

Always use the spark plug, or equivalent, indicated in the above chart.

For spark plug types, please consult your NISSAN/DATSUN dealer or other competent service facility.

Starting and Operating

IN COLD WEATHER

Starting off on slippery roads

When rain or snow makes the roads slippery, use caution in throttling and engaging the clutch. If the clutch is engaged too abruptly and with too much throttle, the wheels will spin and the car may not move forward. To stop the spin, back up a little. Repeatedly rolling backward and forward will get you away from the slippery patch.

In an emergency situation, the car carpet can be used as skid-matting.

Driving on slippery roads

When driving on wet or slippery roads, never brake hard. Instead, shift to a lower gear and use the braking effect of the engine.

When driving on icy roads, always proceed slowly and cautiously, turn the steering wheel gently, and use the brakes only very lightly. Moreover, always change gears smoothly, and never drive with the clutch pedal depressed.

If you should go into a skid, do not apply the brakes. Release the accelerator and turn into the direction of the skid. As the car recovers its balance, straighten out the wheels and accelerate lightly.

Tire equipment

Before starting off over icy or snow-covered roads, it is recommended that snow tires be installed on all four wheels.

Note: When your car is equipped with snow tires, the specified maximum tire pressure of 32 psi (2.2 kg/cm²) should not be exceeded.

Special winter equipment

It is recommended that the following items be carried in the car during winter:

1. A scraper and stiff-bristled brush to remove ice and snow from the windows.
2. A sturdy, flat board to be placed under the jack to give it firm support.
3. A shovel to dig the vehicle out of snowdrifts.

Anti-freeze

[Example]

Coolant capacity	Anti-freeze		
	1 $\frac{3}{8}$ US qt (1 $\frac{3}{8}$ Imp qt, 1.5 liters)	3 $\frac{3}{8}$ US qt (3 $\frac{3}{8}$ Imp qt, 3.0 liters)	4 $\frac{3}{4}$ US qt (4 Imp qt, 4.5 liters)
11 US qt (9 $\frac{1}{4}$ Imp qt, 10.4 liters)	19°F (-7°C)	0°F (-18°C)	-31°F (-35°C)

In the winter when the temperature is anticipated to drop below 32°F (0°C) add anti-freeze solution to the cooling water.

Battery

If the correct specific gravity of the battery electrolyte is not maintained during extreme cold weather condition, the electrolyte may freeze and damage the battery. Therefore to maintain its maximum efficiency it should be checked regularly.

Draining of coolant water

If the car is to be left outside without anti-freeze, drain the coolant by opening the cocks located under the radiator and on the side of the cylinder block.

Replacing lubricant

When the temperature drops below 10°F (-12°C), it is recommended that the lubricating oil be replaced with one of a lower viscosity. Refer to "Recommended SAE Viscosity Number" section.

Starting and Operating

Corrosion protection

In the winter season, streets, roads and highways are often spread with a salt-based compound to melt the snow or ice.

Although this compound is very effective for this purpose, it is not good for the car. It may cause rust and corrosion. To prevent this, rustproofing your car before the winter season is recommended. The rustproofing operation can be performed by your NISSAN/DATSUN dealer.

IN HOT WEATHER

Replacing the lubricant

When the temperature stays over 90°F (32°C), the lubricating oil should be replaced with one of a higher viscosity.

Comfort and Convenience Features

VENTILATION SYSTEM

Two dash side ventilators on the dash enable you to ventilate the car with fresh air in any weather without opening the windows. To draw fresh air into the car, pull out the knob located on the lower right side of the instrument panel.

Flow-away outlets that act like one-way valves are provided in the rear quarter panels. When all the windows are closed, they allow air to flow out of the car but not into it, thereby providing constant and draft-free circulation.

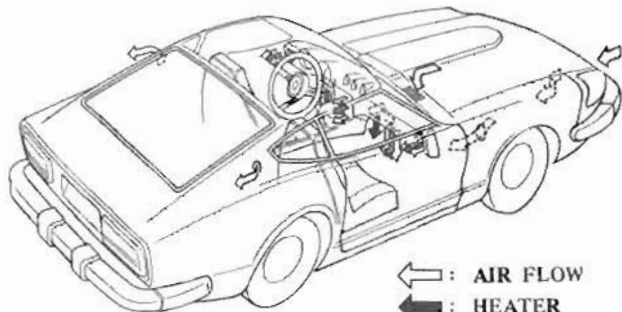

- ← : AIR FLOW
- ← : HEATER
- ← : COOLER
- ← : BI-LEVEL



PUSH; OPEN
PULL; SHUT

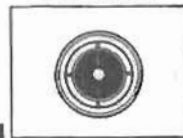

CM463

Comfort and Convenience Features

HEATER

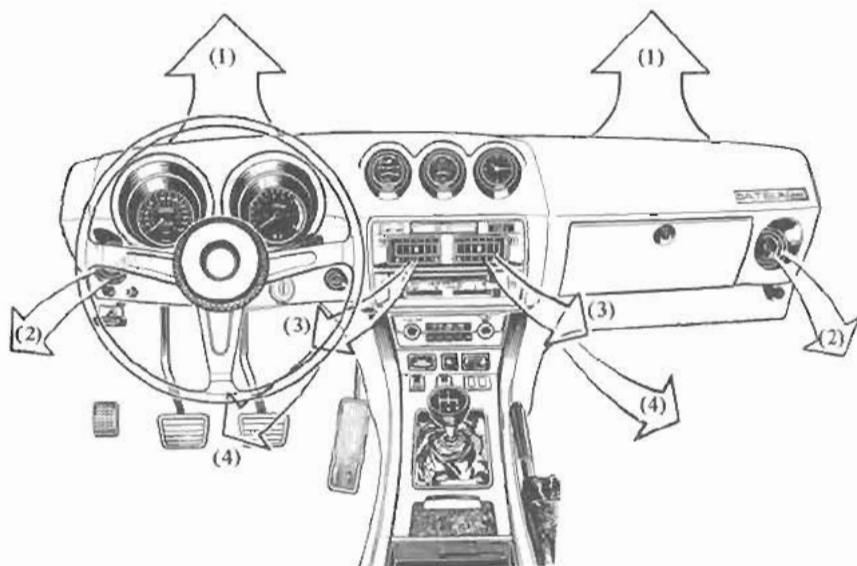
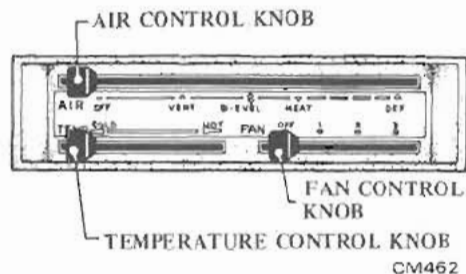

The heating system also includes the function of forced ventilation. To actuate the system manipulate the control lever on the heater control panel.

CM458

Comfort and Convenience Features

To shut off the outside air

Move the "AIR" control lever to the "OFF" position.

Shut off the outside air while driving on dusty roads.

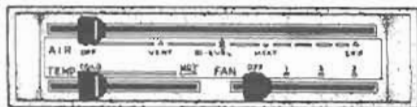

CM464

(4) To heat the car

Move the "AIR" control lever to the "HEAT" position. Move the "TEMP" control lever toward the "HOT" position for the desired temperature.

Pull the "FAN" knob to the desired blower speed.

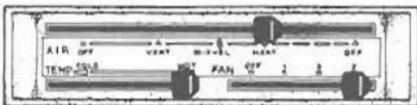

CM460

Heated air is discharged from the lower heater outlets, allowing a small amount of heated air to flow to the windshield glass.

(2) (3) To ventilate the car

Move the "AIR" control lever to the "VENT" position and the "TEMP" control lever to the left.

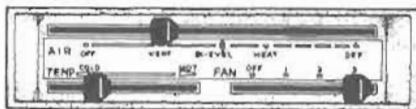

CM459

Outside air is discharged from the center outlets.

Pull side vent knobs at either side of the instrument panel to open the side vent.

Air is discharged from the side vents through the heater fan.

(2) (3) (4) Bi-level operation

Set the "AIR" control lever at the "Bi-level" position, and the "TEMP" control lever at any desired position.

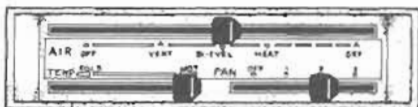

CM461

Outside air is discharged from the center outlets and heated air is discharged from the lower outlets.

(1) To defrost and defog the windshield

Move the "AIR" control lever to the "DEF" position, the "TEMP" control lever to the right and the "FAN" knob to the high speed position.

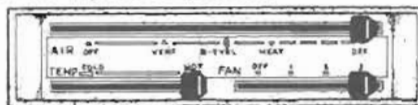

CM462

Heated air is discharged towards the windshield glass.

Note: Head numbers in the above chart coincide with air vents in the figure (CM458).

Comfort and Convenience Features

Operating tips

- Clear any snow and ice from the air inlet in front of the windshield to improve heater and defroster efficiency.
- Always remove snow and ice from the front, side and rear windows to improve defogging efficiency and ensure proper visibility. Remove snow and ice from the outside mirrors and lights at the same time.
- For adequate rear seat heating, always ensure that the areas beneath the front seats are clear, and operate the fan as required.

AIR CONDITIONER

The air conditioning system combines the functions of cooling, heating and ventilating into one unit. The system is operated by the control levers located on the heater control panel.

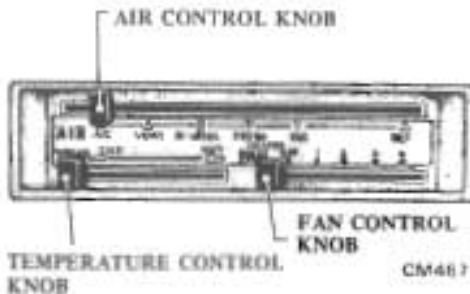

"AIR" control lever

Cooling, heating and ventilating requirements are handled by a variety of systems which can be selected by the "AIR" control lever; this lever must be set at the "A/C" position when cooling is required.

Cooled air is discharged into the interior through five outlets. Three of these outlets are located on the instrument panel: one in the center and one at each side. The other two are located on the right and left sides under the instrument panel.

"TEMP" control lever

The "TEMP" control lever can be set at any position between "COLD" and "HOT" to regulate the cooling temperature to your preference.

The cooling system automatically switches on and off to continually maintain the car interior at the desired cooling temperature.

"FAN" control lever

The fan switch has four positions from 1 to 4. The "4" position of the "FAN" lever is provided for emergency use, at which the maximum air discharge is obtained.

To cool the car

Set the "AIR" control lever at the "A/C" position.

Move the "FAN" control lever to any position other than the "OFF" position.

Floor vent knob

The floor vent knob, located under the instrument panel at driver's side, controls the positioning of the floor vent. When it is set at the middle

Comfort and Convenience Features

position, cooled air is directed to the floor. The vent is shut when the knob is at either end.



CM502

To heat the car

"FRESH" position

With the "AIR" control lever set at the "FRESH" position, outside fresh air drawn into the car is heated and directed to the interior.

"REC" position

In the "REC" position, inside air will be recirculated through the car interior.

This position is useful not only for quickly heating the interior air, but also for driving on dusty roads: it shuts off outside air without hampering the heating function.

AM-FM RADIO

The radio has five push buttons for station selection. Other stations may be selected by the manual tuning knob.

The ignition key must be in "ON" or "ACC" position.

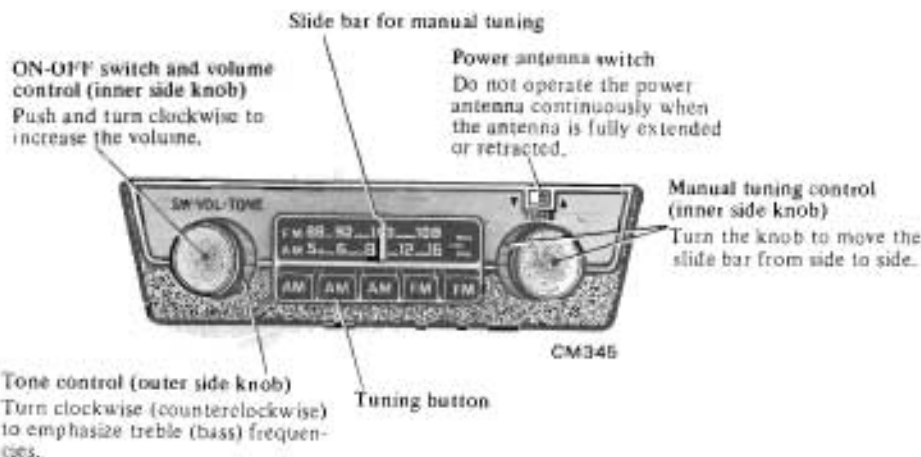

Slide bar for manual tuning

ON-OFF switch and volume control (inner side knob)

Push and turn clockwise to increase the volume.

Power antenna switch

Do not operate the power antenna continuously when the antenna is fully extended or retracted.

Manual tuning control (inner side knob)

Turn the knob to move the slide bar from side to side.

CM345

Tone control (outer side knob)

Turn clockwise (counterclockwise) to emphasize treble (bass) frequencies.

Tuning button

Comfort and Convenience Features

To set push buttons

1. Pull the selector button straight out until it stops. Tune in the station you want with the manual tuning knob at the left side of the radio dial.
2. After the station is clearly tuned in, push the selector button straight in until it stops, then release it.
3. Repeat steps 1 and 2 for the remaining station selector buttons.

Note: The antenna should be fully extended for best reception.

To set push buttons

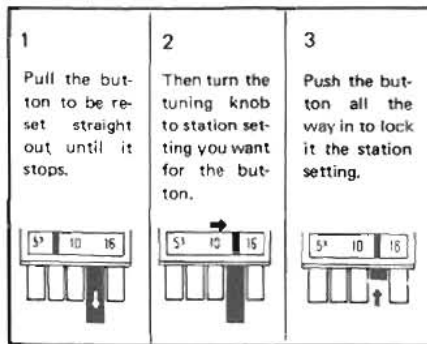

CLOCK

To reset the clock, pull the knob and reset to the desired position.

Turn the knob clockwise to advance the hands, and counterclockwise to retard the hands. Reset the clock on daily basis.

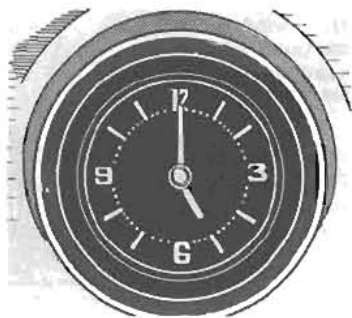

CM348

CIGARETTE LIGHTER

Push the knob in all the way and release it. When the lighter springs back to its original position, it is ready for use.

The lighter illumination light glows in the lighter socket when the light switch is switched on.

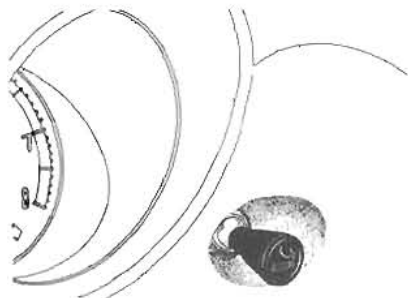

Comfort and Convenience Features

ASH TRAYS

The ash tray is located on floor console.

The ash tray can be easily removed for cleaning by opening its cover and pulling out at the rack.

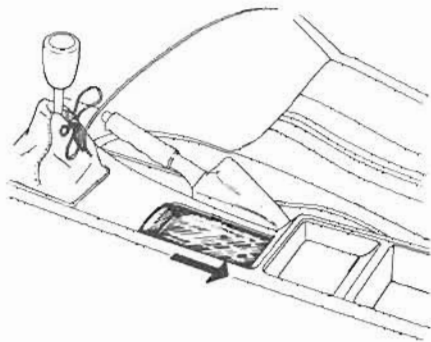

280Z 2+2 model

The ash tray for rear seat occupants is located at the rear end of the console.

It can be removed by depressing the center lever with your finger.

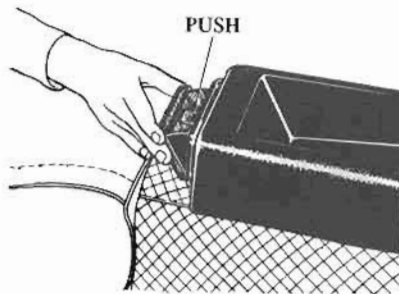

INTERIOR LIGHT

To switch the interior light "ON" and "OFF", push the marked stud.

The interior light comes on whenever the doors are opened, regardless of the switch position.

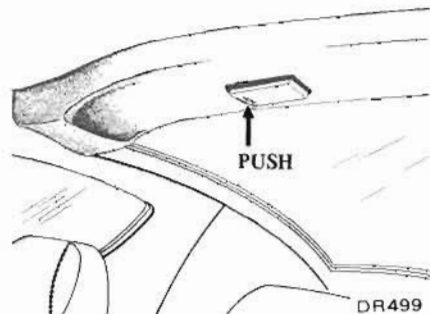

Comfort and Convenience Features

MAP LIGHT

The map light will come on when the map light assembly is pushed downward. It will go out when the assembly is returned to the upward position.



CM457

SUN VISORS

The sun visors can be moved up, down, or side ways.

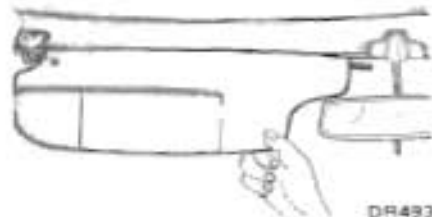

DR493

COAT HANGER (280Z model)

The coat hangers are located on each side of the rear roof.

Note: Do not hang anything on the right coat hook in such a manner that the driver's view to the right rear quarter is obstructed.

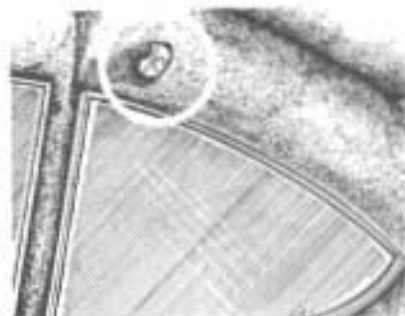

CM350

GLOVE BOX LIGHT

The light will come on when the glove box is opened.

Comfort and Convenience Features

DOOR PULL

A door pull is located on each door.



DR496

REAR SEAT STRAP (280Z 2+2 model)

The strap is located above the roof rail on either side of the rear passenger compartment.

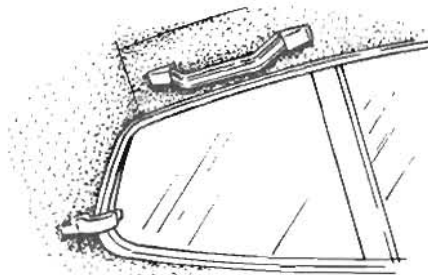

FOOT REST

A convenient foot rest is provided for the driver's left foot.

In cornering, put your left foot on the foot rest to support your body.

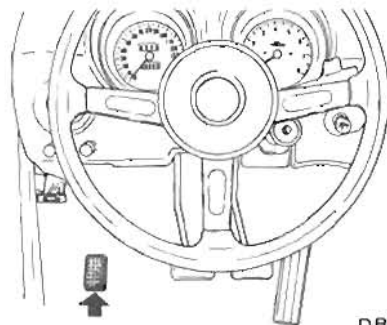

DR495

Comfort and Convenience Features

TAILGATE LOCK

To open the tailgate, insert the key and turn it clockwise. Then push the latch button in.

To lock, insert the key, and turn it counterclockwise.

If the tailgate is unlocked, just push the button to open the gate.

280Z 2+2 model

With the tailgate open, the room light glows.

The tailgate is provided for easy loading or unloading.

To open or close the rear gate, operate the gate lock.

FOLDING REAR SEAT (280Z 2+2 model)

The seat back is equipped with interlocking lock mechanisms on both sides. Release either one and the seat can be folded forward or folded flush to the floor.

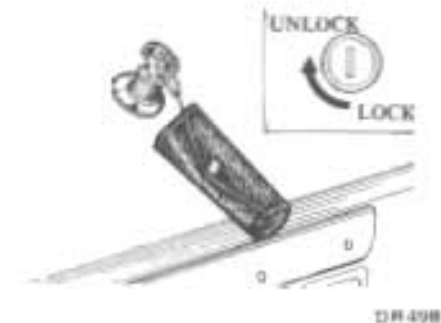

DM498



CM466

BAGGAGE STRAPS

There are straps in the baggage space to secure baggage while travelling.



CM343

INSPECTION LIGHT

The inspection light is located on the left side hood ledge of the engine compartment.

To switch "ON", push the lever down. To remove the light for under-hood inspection, turn the light rim and detach.

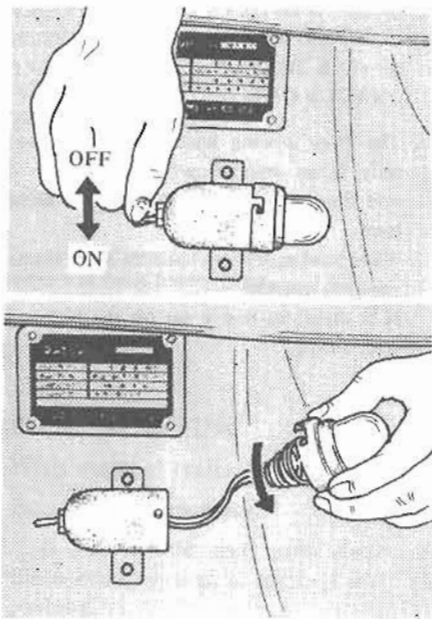

In Case of Emergency

HAZARD WARNING

Use the hazard warning flasher to warn other drivers that your car is disabled or parked under emergency conditions.

Pull off the roadway if possible.

FREEING IMMOBILIZED CAR

If it becomes necessary to rock the car to free it from sand, mud, snow, ice, etc., you should move the gearshift lever from first to reverse in a repeat pattern while simultaneously depressing the accelerator gently. (On automatic transmission models, operate the selector lever from "D" to "R" position).

If the car is not freed by the above procedures, anti-skid materials should be placed under the spinning wheel(s) or the car should be towed out.

Caution: Under such circumstances, avoid racing the engine. This is because one drive wheel spins at twice the speedometer reading when the other drive wheel is stopped resulting in tire and differential damage.

TOWING

It is necessary to use proper towing equipment, to avoid possible damage to the car during a towing operation. Towing information is obtainable from your local NISSAN/DATSUN dealer.

All applicable State (Provincial in Canada) and local laws regarding the towing operation must be obeyed.

Before towing your car, make certain that the parking brake is fully released and the transmission is in neutral.

Cautions:

- a. The ignition key must be turned to the OFF position and remain in the ignition. Do not remove the key during the towing operation, as this will lock the steering column and damage the lock mechanism.
- b. If the car equipped with the automatic transmission is towed with rear wheels on the road, the towing speed should not exceed 20 MPH and the towing distance should not exceed 6 miles. If this is not possible, tow the car with the rear wheels raised.

Warning:

- a. Only the front hooks at the right and left sides may be used for towing purposes. When front hooks are used for towing, remove front apron and front fender front to prevent possible interference with towing rope.

BE SURE TO HAVE THE REAR HOOKS REMOVED AT YOUR NISSAN/DATSUN DEALER IF THEY HAVE BEEN LEFT ON YOUR CAR.

- b. The front towing hooks should be used only in an emergency situation, e.g., to pull the car out of a ditch, a snow bank or mud. When towing, do not take up slack in the rope too quickly. It is illegal to tow a car on the highway with a rope.

In Case of Emergency JUMP STARTING WITH BOOSTER BATTERY

Because explosive hydrogen gas is always present in the vicinity of the battery, keep all sparks and flames away from it. Whenever charging or using a battery in a closed environment always ensure that there is suitable ventilation.

Do not, under any circumstances, allow battery fluid to come into contact with eyes, skin, cloth or painted surfaces. Battery fluid is a corrosive sulphuric acid solution which can cause severe burns. If the fluid should come into contact with anything, immediately flush any contacted area with water.

Whenever working on or near a battery, always wear suitable eye protectors (e.g. goggles or industrial safety spectacles)

Keep out of the reach of children.

If done incorrectly, jump starting can be hazardous.

Always follow the instructions below.

1. Position the two cars in such a manner that their battery cases are in close proximity to each other. Set

As the push begins, turn the ignition to "ON", place the shift lever in second or third gear, and keep your foot all the way down on the clutch pedal. Hold the accelerator pedal about halfway down. When the car reaches a speed of about 10 MPH (15 km/h), slowly release the clutch pedal to start the engine.

CAUTION:

NEVER TRY TO START THE CAR BY TOWING IT; WHEN THE ENGINE STARTS, THE FORWARD SURGE COULD CAUSE THE CAR TO COLLIDE WITH THE TOW VEHICLE.

For California models

Models destined for sale in California should not be pushed or towed to start, or the catalytic converter may be damaged.

With automatic transmission

Cars equipped with automatic transmissions cannot be started by pushing.

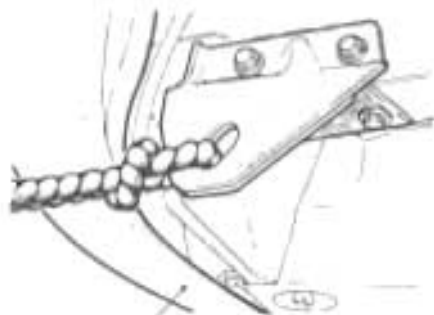

To prevent damage, remove the front apron and front fender front.

Wh171

PUSH STARTING

With manual transmission

Except California models

If you cannot start your engine in the normal manner, it can be started by pushing.

In Case of Emergency

parking brakes. On manual transmission models set the gear lever in "neutral", on automatic transmission models set the lever in "park". Switch off all unnecessary electrical systems (light, heater, etc.).

Cautions:

- a. If it becomes necessary to start the engine with a booster battery and jumper cables, the booster battery voltage must not exceed 12 volts, or the control unit of the fuel injection system and other electric components will be damaged.
- b. If the battery cables are disconnected, they should be tightly clamped to the battery terminals to secure a good contact.

2. To reduce the explosion hazard inherent in connecting a live booster battery to a discharged battery, remove the vent caps from both batteries and place a cloth over their open vent wells.
3. Run one jumper cable from the positive terminal of the booster battery to the positive terminal of the discharged battery.
4. Connect the other cable to the booster battery's negative terminal and to the engine lift bracket of the car with the discharged battery.

Caution:

Never confuse these jumper cable connections. If connections deviate from that described in the foregoing, damage to both charging systems or even serious personal injury could result.

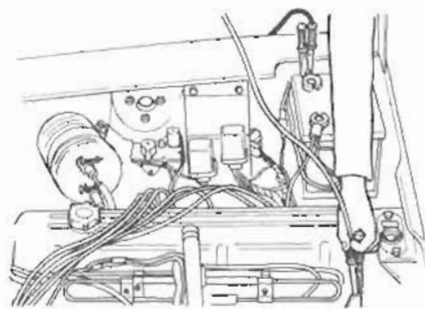

IN517

5. Start the engine of the other car. After letting it run for a few minutes, start your engine in the normal manner.
6. Once you have your engine running carefully disconnect the jumper cables, exactly reversing the connection procedure.
7. Replace the vent caps. Because the cloths used to cover the vent wells may have been contaminated with corrosive acid, be sure to dispose of them in a safe manner.

The following precautions should be observed while servicing the electrical systems of your car.

- Never reverse battery polarity.
- Never connect or disconnect either the battery or any transistorized component while the ignition key is turned on.

OPENING THE HOOD

To unlock, pull the hood lock handle located below the instrument panel.

To open the hood, release the safety catch located under the center edge of the hood and raise the hood. To keep the hood opened, insert the stay in the hole in the hood. To close the hood, fasten the stay to the stay clamp and lower and push it down firmly until the hood latch is completely engaged.

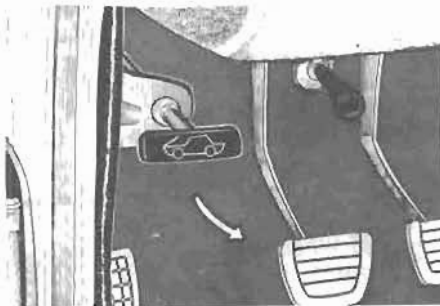

DA182

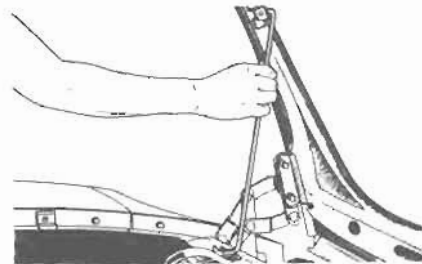

DA184

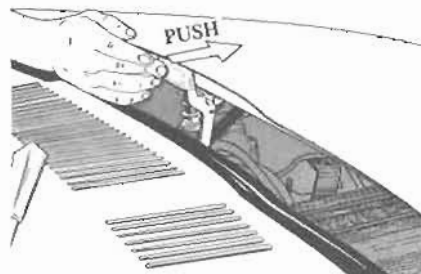

DA183

Maintenance

OPENING THE INSPECTION LID

To inspect the battery or the windshield washer tank, open the hood, and then the inspection lid.

Shut the inspection lid, and the hood, in that order when closing.



DA185

ROUTINE SERVICE

The following items should be checked daily and/or weekly, or whenever you refuel.

- Engine oil level
- Engine coolant level
- Brake and clutch fluid level
- Windshield washer fluid level
- Battery electrolyte level
- Tire inflation pressures

Engine oil level

The engine oil should be maintained at the correct level. The best time to check it is before operating the engine or as the last step in a refueling stop. This will allow oil accumulated in the engine to drain back into the crankcase.

To make an accurate oil level check:

1. Park the car on a level surface.
2. Remove the dipstick and wipe it clean.
3. Reinsert it all the way into the tube for an accurate reading.
4. Remove the dipstick and check the oil level. It should be between the "H" and "L" marks.
5. After taking the reading, reinsert the dipstick.

If the oil level is at or below the "L" mark, add sufficient oil into the oil filler, located on the cylinder head cover, to raise the level to the "H" mark. Do not overfill.

It is not abnormal to add some oil between oil changes or during the break-in period, depending on the severity of operating conditions.

Engine oil capacity

- Oil pan: 4 $\frac{1}{4}$ U.S. qt.
(3 $\frac{3}{4}$ Imper. qt., 4.0 liters)
- Oil filter: 1 $\frac{1}{2}$ U.S. pt.
(1 $\frac{1}{4}$ Imper. pt., 0.7 liter)

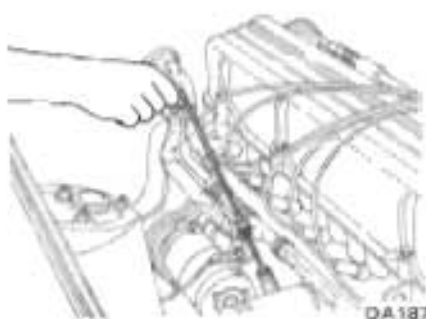

DA187



DA147

Engine coolant level

Genuine NISSAN permanent anti-freeze coolant (ethylene glycol base) is used in the system. Protection down to -31°F (-35°C) will be insured with a 50% Anti-freeze Coolant ratio.

The radiator of your DATSUN is equipped with a 13 psi (0.9 kg/cm²) pressure cap.

Under extreme weather conditions the engine coolant will probably exceed the boiling point but will not boil because of the higher pressure within the cooling system due to the pressurized cap.

Whenever coolant is changed, the cooling system should be flushed and refilled with a permanent anti-freeze coolant. See the instructions attached to the anti-freeze as to the ratio of anti-freeze and water.

If it becomes necessary to frequently add coolant, your cooling system should be inspected by your NISSAN/DATSUN dealer or other competent service facility.

WARNING:

Never remove the radiator pressure cap when the engine is hot, because there is a danger of being seriously burned by high pressure fluid escaping from the radiator. Always be sure to allow the engine to cool off by idling for several minutes before removing the cap. Carefully remove the cap by turning it a quarter turn to allow built-up pressure to escape and then turn the cap all the way off. It is advisable to cover the cap with a cloth before turning it.

Models equipped with a reservoir tank

Visually check the amount of coolant in the reservoir tank. If the coolant level is below the **LOW** level, remove the reservoir tank filler cap and add coolant to the midpoint between the **FULL** and **LOW** level marks on the tank.

If the reservoir tank is empty, check the coolant level in the radiator. If the coolant in the radiator is insufficient, pour it into radiator up to the radiator cap and also pour it into the reservoir tank up to the **LOW** mark.

If the coolant in the reservoir tank decreases abnormally rapid, the cooling system should be inspected by your NISSAN/DATSUN dealer or other competent service facility.

Brake and clutch fluid level

To check the fluid level, turn the reservoir cap outer ring counterclockwise and pull it upwards.

Fluid level should be maintained at the level marked on each reservoir. If the fluid level falls considerably below this level, the brake system should be thoroughly checked by your NISSAN/DATSUN dealer.

Maintenance

To install the cap, press it down firmly and turn the outer ring clockwise until it stops.

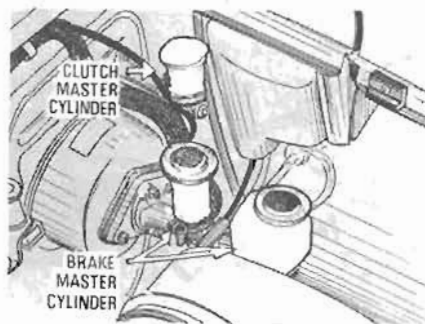

DA192

Windshield washer fluid level

Check fluid level in the reservoir and add if necessary.

Add a windshield washer solvent to the water as clear water is usually not adequate for cleaning the windshield. In winter season, add a windshield washer anti-freeze and follow the manufacturer's instructions for the correct amount to be used.

Notes:

- Do not operate the washer continuously more than thirty seconds.
- In cold weather, defrost the windshield glass before operating the washer.
- Do not wipe the glass with a dry cloth, it may scratch the glass.

Caution: Do not substitute radiator anti-freeze for windshield washer solution. This may result in damage to the paint work.

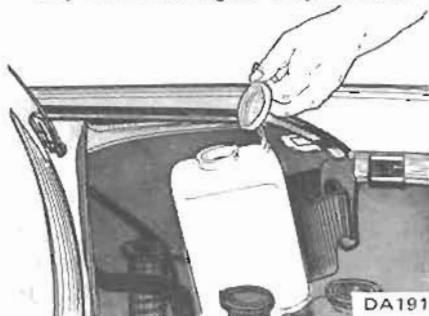

Battery electrolyte level

Check the fluid level in each filler. If necessary, add only distilled water to bring the level to the indicator in each filler opening. Do not overfill.

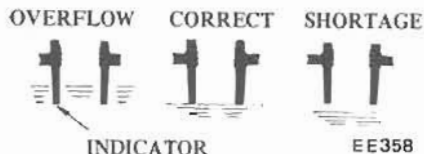

Caution: Do not expose the battery to flames or electrical sparks. Hydrogen gas generated by battery action is explosive. Do not allow battery fluid to come in contact with skin, eyes, fabrics, or painted surfaces. If the acid contacts the eyes, skin or clothing, immediately flush with water for 15 minutes and seek medical attention. In freezing weather, run the engine for a while after adding distilled water, to make sure that the water mixes properly with the fluid. Otherwise the water may freeze and damage the battery.

Tire inflation pressures

Tire pressure should be checked when tires are COLD. Proper tire pressures are shown on the tire plate affixed to your car and listed in the following chart.

If tires are not properly inflated, tire life and car performance may be adversely affected. Insufficient air pressure may cause tires to become overheated, and may result in uneven wear, poor car handling characteristics and excessive fuel consumption.

Excessive air pressure may not only cause uneven tire wear and poor car handling characteristics, but may also lead to increased vulnerability to damage from road surface impact.

Do not allow inflation pressures to exceed the maximum value shown on the side wall of the tire.

COLD pressure: After car has been parked for three hours or more or driven less than 1 mile (1.6 km).

Note: Since a hot tire will exceed the specified COLD pressure, do not bleed air out of hot tires.

- The tire should be replaced, when the "tread wear indicator" appears across the tread as a solid band. "Tread wear indicator" marks are in six positions on the tire circumference, which indicate 0.06 in (1.5 mm) tread depth remaining.

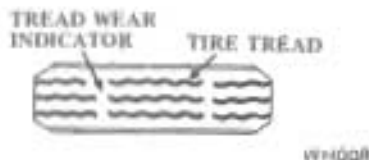

Caution: The car capacity weight is indicated on the tire plate. DO NOT load your car beyond this capacity. Overloading your car may result in reduced tire load carrying capacity and could also lead to a serious accident.

Before taking a long trip, or whenever you have loaded your car heavily, use a tire pressure gauge to ensure that the tire pressure is at the specified level.

Recommended cold tire inflation pressure

Unit: psi (kg/cm²)

Tire size	For normal speed [under 100 MPH (160 km/h)]	For high speed [over 100 MPH (160 km/h)]
195/70HR14	28 (2.0)	32 (2.25)
175HR-14	28 (2.0)	32 (2.25)

For high-speed driving, inflate the tires to the pressure specified in the chart when they are cold.

Maintenance OIL AND FUEL RECOMMENDATION

Fuel recommendation

Your DATSUN (except those bound for California) is designed to operate on either unleaded or low-lead gasoline with a research octane rating of at least 91.

ALL CALIFORNIA STANDARD MODELS ARE DESIGNED TO OPERATE ON UNLEADED GASOLINE ONLY OF AT LEAST 91 OCTANE (RON).

UNDER NO CIRCUMSTANCES SHOULD A LEADED FUEL BE USED SINCE THIS WILL DAMAGE THE CATALYTIC CONVERTER.

Incorrect ignition timing, or the use of a fuel whose octane rating is too low, will result in knocking, after-run or overheating.

This in turn will cause excessive fuel consumption or damage to the engine. If any of the above symptoms are encountered, use of a fuel with higher octane number is recommended. Should the condition persist, immediately have your car checked at a NISSAN/DATSUN dealer or other competent service facility.

Engine oil recommendation

Use only the engine oil listed in the Recommended Lubricant Specifications. Change engine oil at the intervals recommended in the Emission Control Maintenance Schedule. It should be noted that oil change intervals longer than those listed above will seriously reduce engine life.

Operation under the following conditions may require more frequent oil changes.

- short distance driving at cold outside temperatures,
- driving in dusty conditions,
- severe driving.

Recommended SAE viscosity number

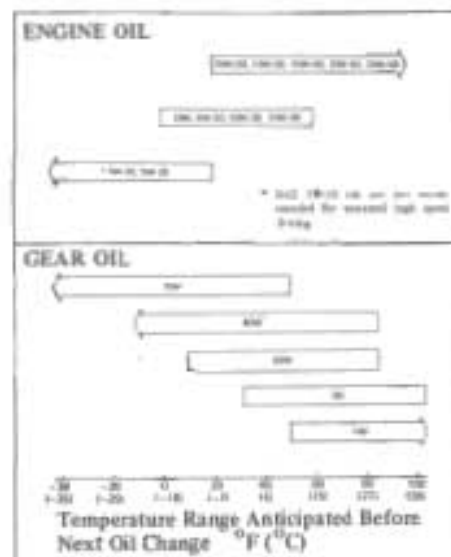

Recommended lubricant specifications

Item		Specifications	Remarks
Gasoline engine oil		SAE Classification SD or SE	Furthermore refer to SAE recommended viscosity table. See page 50.
Gear oil	Transmission and steering	API GL-4	_____
	Differential	API GL-5	_____
Automatic T/M fluid		Type DEXRON	_____
Multipurpose grease		NLGI 2	Lithium soap base
Brake and clutch fluid		DOT 3	_____
Antifreeze		_____	Permanent anti-freeze (Ethylene glycol base)

MINOR MAINTENANCE

The following are the minor checks that you can make periodically. If any deficiencies are found, regarding the need for repairs or replacements, the maintenance can be performed by your NISSAN/DATSUN dealer.

Hood lock

- Check the hood to see if it is closed and locked properly.
- Lubricate hood lock assembly periodically as recommended in the "Periodic Maintenance and Lubrication Schedule" section.
- Apply grease to all functioning parts after wiping off any accumulation of dirt on lock parts.
- Ensure that the lock and release mechanisms work smoothly by operating several times.

Maintenance

Battery

The battery surface should be clean and dry. Periodically apply a small amount of grease or petroleum jelly to each terminal to prevent corrosion.

Caution: If it becomes necessary to start the engine with a booster battery and jumper cables, the booster battery voltage must not exceed 12 volts, or the control unit of the fuel injection system and other electric components will be damaged.

Automatic transmission fluid

Check the fluid level at the intervals recommended in the "Maintenance Schedule". To make an accurate fluid level check:

1. Drive the car several miles to bring the transmission up to normal operating temperature. [Approximately 160°F (71°C)].
2. Park the car on a level surface and apply the parking brake.
3. Place the selector lever in park "P" position and leave the engine running.
4. Remove the dipstick and wipe it clean with lint-free cloth.
5. Reinsert the dipstick all the way into the filler pipe.
6. Remove the dipstick and note the reading.

If fluid level is at or below the "L" mark, add sufficient fluid to raise the level to the "H" mark.

Caution:

- Use a clean funnel and do not overfill as this will cause foaming and subsequent loss of fluid which may result in trans-

mission malfunction.

- In checking oil level, handle the oil level gauge with a lint-free cloth.

For the recommended automatic transmission fluid, see the "Recommended Lubricant Specifications".

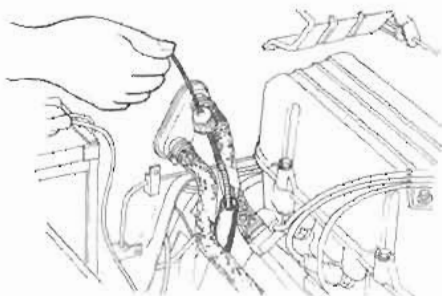

M1207



M1056

Spark plugs

If you experience any problem with the spark plugs, remove and inspect them for deposits and electrode erosion. Light brown or gray deposits on the firing tips indicate good combustion.

After cleaning carefully, adjust the plug gap to the specified value, as shown on page 88. Plugs do not last forever. Replace them periodically, as recommended in the "Emission Control Maintenance Schedule" section, even if they look good.

Windshield wiper blades

Check the wiper blades for operation and cleanliness. If the wiper blades do not wipe the windshield clean after the blades have been wiped off with a cloth, replace the blades.

To adjust the washer spray, move the nozzles toward the center of each half of the windshield.

Fuses

Fuses are located on the side wall under the dash board.

Before replacing any fuse, be sure to check the fuse specifications listed on the fuse box cover. Never use a fuse of a higher amperage rating than that specified.

The wiring system contains special wire fusible links. The fusible links are located on the engine compartment relay bracket and at the battery positive terminal of the electronic fuel injection harness. Should an overload occur, these fusible links are designed to melt so as to prevent damage to the wiring harness (for ignition, electronic fuel injection system, lights and alternator).

If it becomes necessary to replace a fusible link, it must be replaced with one of an equal rating.



M1296

Maintenance

Bulb specifications

	Wattage	Trade number
Headlight unit	50/40 watts	6012
Side clearance and turn signal light	8/23 watts	1034
Side marker light	8 watts	67
License plate light	7.5 watts	89
Rear combination light		
Taillight	8/23 watts	1034
Stop (brake) light		
Turn signal light	23 watts	1073
Back-up light	23 watts	1073
Meter illuminating light	3.4 watts	57X
Brake warning light	3.4 watts	57X
Turn signal indicator light	3.4 watts	57X
Headlight beam indicator light	3.4 watts	57X
Engine compartment inspection light	8 watts	67
Interior lights	10 watts	-
Glove box light	3.4 watts	57X
Clock illumination light	3.4 watts	57X
Cigar lighter illumination light	1.7 watts	-
Hazard illumination light	1.4 watts	-
Heater control illumination light	3.4 watts	57X
Seat belt warning light	1.4 watts	-
Rear defogger indicator light	1.4 watts	-
Floor temperature warning light	1.4 watts	-
Fuel warning light	3.4 watts	57X
Charge warning light	3.4 watts	57X

Bulb replacement

The following procedure should be used in replacing all bulbs.

Headlight

To replace this unit, follow the procedure below:

1. Disconnect connector behind front fender panel.
2. Remove four screws retaining headlamp housing to fender panel. These screws can be removed through wheel opening of front fender panel.
3. Remove headlamp assembly from body.

Then, remove headlamp retaining ring by loosening three screws. Retaining ring can be taken out by rotating it clockwise.

Note: Be careful not to disturb aiming adjusting screws.

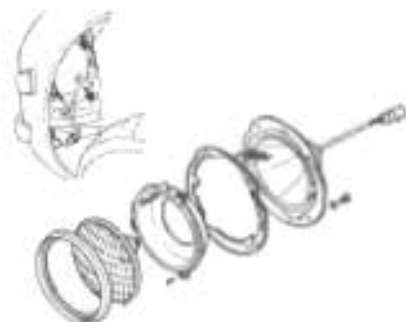

Front combination light

1. Remove the two screws and remove the lens.
2. Push in on the bulb, twist it counter-clockwise, and remove it from socket.
3. Insert a new bulb into the socket, press it inward and rotate it clockwise. Make sure that the bulb is locked in the socket.

4. Remove sealed beam unit from housing, and disconnect connector. The sealed beam can then be taken out.
5. The new unit should be installed in the reverse sequence of removal. When aiming adjustment is necessary, see your dealer or other competent service facility.

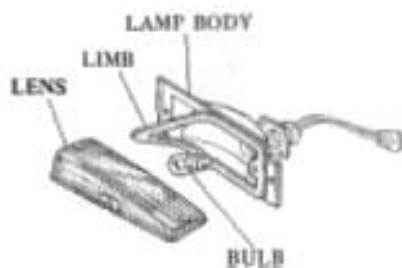

BEG14A

Side marker light (Front and Rear)

1. Remove two lens retaining screws.
2. Remove lens from lamp body.
3. Push in on bulb, twist it counter-clockwise and remove from socket.
4. Insert new bulb into socket, press it inward and rotate it clockwise. Make sure that bulb is locked in socket.
5. Install lens in the reverse sequence of removal.

FRONT

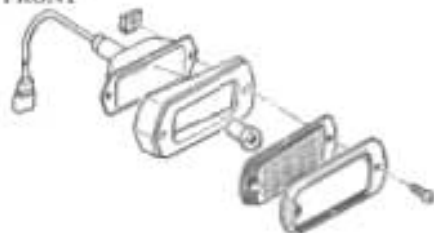

REAR

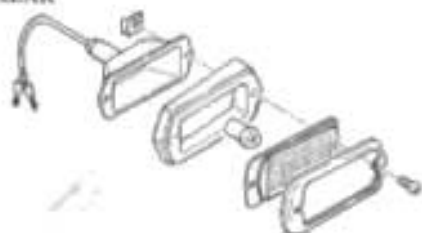

Maintenance

Rear combination light

To replace the bulb, remove the trim cover (four screws) from inside baggage compartment.

Then remove bulb from the socket.

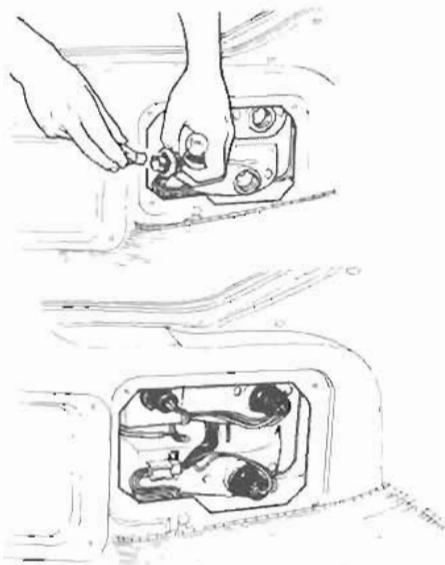

MI298

License plate light

1. Remove two screws retaining light body to rear panel and take out light body.
2. Twist socket counterclockwise and remove socket, with bulb, from light body.
3. Push in on bulb and twist it counterclockwise. Bulb can then be easily removed from socket.
4. Install new bulb in the reverse sequence of removal.

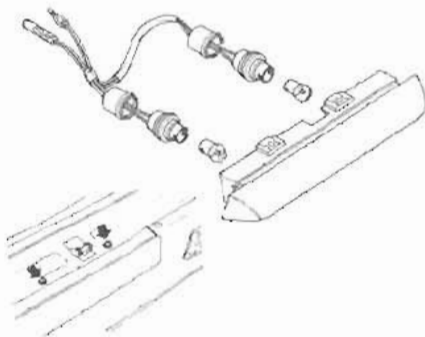

Interior light

1. Remove interior light assembly from roof. Interior light is retained by the spring.
2. Pulling light body out a little, disconnect three connectors.
3. Remove bulb from light body through the hole.
4. Install new bulb in the reverse sequence of removal.

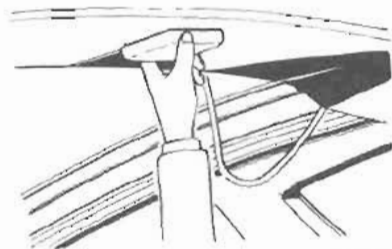

MI299

WHEEL AND TIRE

Tire care

Tire should be replaced if the tread depth is less than 0.063 in (1.6 mm) and/or if tire is damaged.

When replacing a worn or damaged tire, use a replacement tire of the same size and load carrying capacity as that with which the car was equipped when manufactured. The use of different size and/or load capacity tires will not only shorten tire service life but may also result in a serious accident. The use of tires and wheels other than those recommended or the mixed use of tires of different brands or tread patterns can adversely affect the ride, handling ground clearance, body-to-tire clearance, and speedometer calibration.

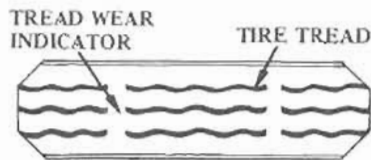

Tire rotation

Periodic rotation of tires (including the spare tire) will serve to minimize tire problem and will result in longer tire life.

Tires should be rotated periodically as recommended in the following rotation system.

– Radial ply tires –

- All the tires including the spare tire are of the same type.

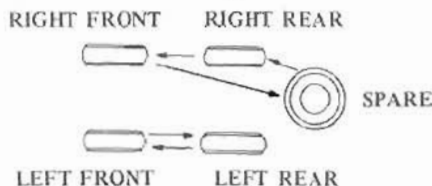

- If the spare tire is a different brand from the 4 tires on the car.

Caution: Bias, bias belted and radial ply tires must not be mixed under any circumstances.

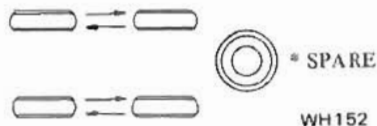

- * Regardless of tire brand the spare tire should be used in an emergency only.

As to the tire rotation interval, refer to "Periodic Maintenance and Lubrication Schedule" section.

Maintenance

Changing tires

When changing tires, carefully take the following steps.

1. Park on a level surface and set parking brake firmly. Set manual transmission in reverse (automatic transmission in "P").
2. If parked on or near road, activate hazard warning flasher.
3. Remove the spare tire and tools from the stowage compartment.
4. Block the rear wheel opposite to the wheel to be changed with wheel chocks.
5. Place the jack under the jack-up point indicated.
6. Using the flat end of the wheel nut wrench, remove the wheel cover and loosen $\frac{1}{2}$ wheel nuts one or two turns each by turning them counterclockwise.

Note: Do not remove the wheel nut until the wheel is raised off the ground.

7. Raise the car slowly until the wheel clears the ground. Remove the wheel nuts and replace the wheel.
8. Slightly tighten the wheel nuts alternately and evenly by turning

them clockwise. Be sure that the beveled end of the nuts faces inward.

9. Lower the car slowly until the wheel touches the ground, and then securely tighten the wheel nuts in the same sequence.

Note: Adjust the tire pressure to the specified value indicated on the tire placard.

10. Replace the wheel cover, remove the wheel chocks, replace the tools and spare tire.

Caution: Never get under the car while it is supported only by the jack.

Always use safety stands to support the frame when you have to get under the car. Do not start or run engine while car is on the jack.



M1300

JACK-UP POINTS

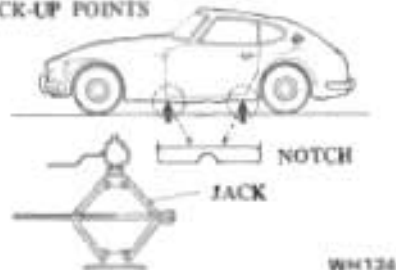

WH124

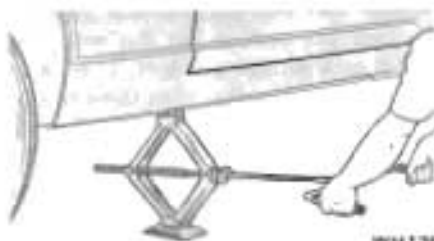

WH126



WH125

Changing wheels

Wheels should be replaced if deformed or excessively rusted. Replacement wheels must be the same size, loading capacity, offset, etc. as those installed at the factory. Failure to observe this rule may degrade car performance.

Note:

- It is advisable that the deformed wheel not be reinstalled, even if repaired.
- It is recommended that a tube not be used on a tubeless tire wheel.
- Avoid installing a used wheel. If the wheel has been used under severe operating conditions, its life may have been significantly shortened.

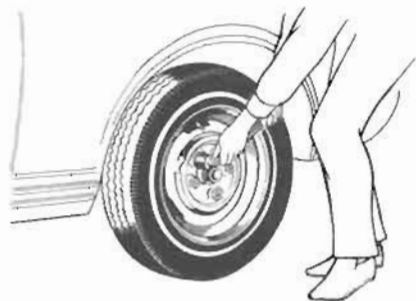

WH092

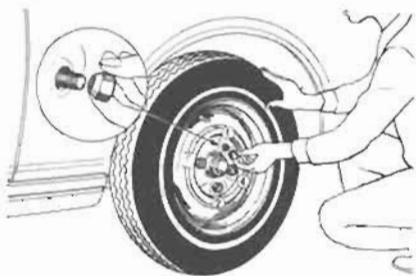

WH093

Tire damage and repair

Tires should be periodically inspected for scratches, bulging or objects caught in the tread. If cracks, bulging or deep cuts are found, the tire should be replaced. If a tire is suspected of being unsafe, it should be taken to your NISSAN/DATSUN dealer or other competent service facility.

If blow out or sudden loss of pressure occurs while driving, do not travel further than is necessary to stop safely. Driving even a short distance can damage a tire beyond repair.

Temporary measures, such as use of patches or other items applied to the outside of the tire, should not be taken except in emergencies.

If they must be used, keep in mind the temporary nature of these measures and go to the NISSAN/DATSUN dealer or other competent service facility as soon as possible for complete repair.

Maintenance

Care of aluminum wheels

- Wash the wheels while washing the rest of the car to maintain their appearance.
- Clean the inner side of the wheels each time one is changed or the underside of the car is washed.

Caution:

1. Do not use abrasive cleaners when washing the wheels.
2. Inspect wheel rims regularly for dents or rusts, which cause loss in pressure and damage tire bead.
3. Consider the application of car wax to protect against salt chloride used during the winter.
4. The wheel nut tightening torque is 58 to 65 ft-lb (8 to 9 kg-m).
5. Use the wheel nut for exclusive use in aluminum wheels.



FOR ALUMINUM
WHEELS ONLY



FOR STEEL
WHEELS ONLY

WH17B

Spare tire

The spare tire is located in the luggage compartment. Remove the carpet and cover board, then release the spare tire clamp.



WH138

TOOLS

The tools are installed in the tool box at the front of the rear floor.

To eliminate the possibility of the jack and wheel chocks rattling while the car is moving, stow them properly.

Jack and wheel chocks stowage instructions are outlined on the label on the tool cover board.

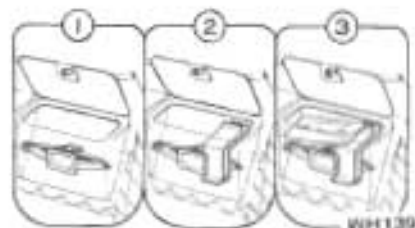

WH139

280Z 2+2 model

The tool bag is stowed under the left rear mat and secured with a rubber strap. The tire stopper is of a folding design which should be kept inside the tool bag when not in use.

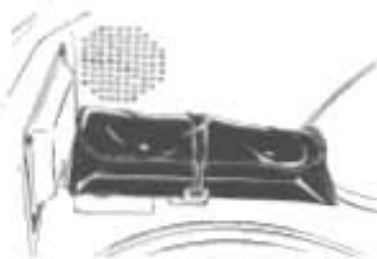

The jack should be stowed in front of the left rear seat with the cover on. It can be taken out by turning the jack handle counterclockwise and pushing the jack head down.

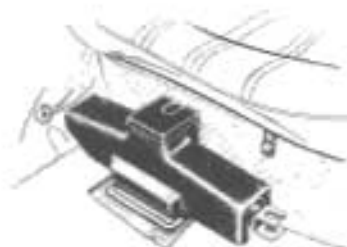

CLEANING YOUR CAR

The finish and upholstery on your car continually receives abuse from industrial fumes, dirt, mud, road salt, etc.

Yet your car will always look well-cared for if you follow these helpful hints on car care.

The best way to preserve the finish and maintain its original beauty is to keep it clean.

The longer dirt is left on the surface, the greater the probability of some damage to the finish.

In areas where excessive road salt is used, the car should be cleaned more often to protect the finish.

The underside of the car also picks up dirt and road salt which should not be allowed to build up.

Therefore, the underside of the car should be sprayed with a powerful jet of water, at regular intervals, to remove these corrosive deposits.

Maintenance

Washing your car

Spray water over the car to remove loose dirt.

Clean with a soft bristle brush and soap and water solution.

Rinse well. Wipe with a chamois to keep from water-spotting.

Removing spots

Remove spots from the painted surface as soon as possible to prevent staining.

Tar or road oil

Remove tar or oil immediately as permanent staining may result.

Use a tar and road oil remover. If you do not have a remover, use kerosene. Then wash with a soap and water solution. Wax to preserve the finish.

Insects or tree sap

Remove with a lukewarm soap and water solution. Do not allow tree sap to harden on the paint surface.

Waxing

Apply liquid wax or paste wax to obtain a long-lasting, durable finish.

Wax at periodic intervals, depending on the environment where your car is used.

Leatherette and interior trim

Wipe leatherette and interior trim clean with a damp or wet cloth or use a recommended cleaner.

Caution: Make sure the cleaner selected is not harmful to the material.

Cloth upholstery and carpet

Clean with a vacuum cleaner or hard brush.

Stains should be removed with a soap and water solution or a spot remover. Wipe with a damp clean cloth from outside of stain toward center.

Caution: Only use spot removing fluids in a well ventilated area and keep out of the reach of children.

Do not use gasoline, kerosene, naphtha, nail polish remover or other volatile cleaning fluids. They may be toxic or flammable or hazardous in other ways.

Cleaning the vinyl top

Wash the vinyl top frequently, using neutral soap suds, water and a soft bristle brush.

Rinse well to remove all traces of soap.

If additional cleaning is required, a mild cleanser can be applied.

After cleaning the entire top, rinse with clean water to remove all traces of cleanser.

Note: Do not apply volatile cleanser or household bleaching agents to the vinyl top.

PERIODIC MAINTENANCE AND LUBRICATION SCHEDULE

Before delivery of your new car, your Dealer provides a pre-delivery inspection and adjustment service specified by the factory and designed to ensure satisfactory performance.

The following tables list the servicing required to keep your car operating at peak mechanical condition, and should be attended to as indicated, preferably by a NISSAN/DATSUN dealer or other competent service facility.

UNDER HOOD MAINTENANCE

MAINTENANCE OPERATION (Periodic maintenance should be performed at number of miles (km) or months, whichever comes first.)	Number of miles in thousands (Number of kilometers in thousands)	MAINTENANCE INTERVAL										
		1,000 miles (1,600 km)	6.25 (10)	12.5 (20)	18.75 (30)	25 (40)	31.25 (50)	37.5 (60)	43.75 (70)	50 (80)	56.25 (90)	62.5 (100)
		Number of months										
Brake, clutch, automatic transmission & steering gear fluid levels & leaks		I	I	I	I	I	I	I	I	I	I	
Brake fluid				R		R		R		R		
Master-Vac vacuum hoses & check valve			I	I	I	I	I	I	I	I	I	
Air conditioning system hoses, connections & refrigerant leaks		I	I	I	I	I	I	I	I	I	I	

Abbreviations: I: Inspect, correct/replace if necessary R: Replace

UNDER VEHICLE MAINTENANCE

MAINTENANCE OPERATION (Periodic maintenance should be performed at number of miles (km) or months, whichever comes first.)	Number of miles in thousands (Number of kilometers in thousands)	MAINTENANCE INTERVAL										
		1,000 miles (1,600 km)	6.25 (10)	12.5 (20)	18.75 (30)	25 (40)	31.25 (50)	37.5 (60)	43.75 (70)	50 (80)	56.25 (90)	62.5 (100)
		Number of months										
Brake, clutch, fuel & exhaust systems for proper attachment, leaks, cracks, chafing, abrasion, deterioration, etc.		I	I	I	I	I	I	I	I	I	I	
Manual transmission & differential gear oil		R	I	I	I	R	I	I	I	R	I	
Steering gear box & linkage, suspension parts & propeller shaft for damaged, loose & missing parts		I		I		I		I		I		
Steering linkage & front suspension ball joints						L				L		
Resistor body mountings		I				I				I		

Abbreviations: I: Inspect, correct/replace if necessary L: Lubricate
R: Replace

Maintenance

OUTSIDE AND INSIDE MAINTENANCE

MAINTENANCE OPERATION [Periodic maintenance should be performed at number of miles (km) or months, whichever comes first]	Number of miles in thousands (Number of kilometers in thousands) <hr/> Number of months	MAINTENANCE INTERVAL											
		1,000 miles (1,600 km)	6.25 (10)	12.5 (20)	18.75 (30)	25 (40)	31.25 (50)	37.5 (60)	43.75 (70)	50 (80)	56.25 (90)	62.5 (100)	
		6	12	18	24	30	36	42	48	54	60		
Rotate wheel position & inspect wheel balance & wheel alignment			I		I		I		I		I		I
Disc brake pads & other brake components for wear, deterioration & leaks	(1)	I	I	I	I	I	I	I	I	I	I	I	I
Brake drums, linings & other brake components for wear, deterioration & leaks	(1)			I			I		I		I		I
Wheel bearing grease						R					R		
Locks, hinges & hood latch	(1)		L	L	L	L	L	L	L	L	L	L	L
Seat belts, buckles, retractor, anchors & adjuster				I		I		I		I		I	
Foot brake, parking brake & clutch for free play & operation Master-Vac & NP-valve for operation		I	I	I	I	I	I	I	I	I	I	I	I

NOTE: (1) If vehicle is operated in areas using road salt or other corrosive materials, inspect every 3,000 miles (5,000 km) or 3 months, whichever comes first. Abbreviations: I: Inspect, correct-replace if necessary L: Lubricate

ROAD TEST

MAINTENANCE OPERATION [Periodic maintenance should be performed at number of miles (km) or months, whichever comes first]	Number of miles in thousands (Number of kilometers in thousands) <hr/> Number of months	MAINTENANCE INTERVAL											
		1,000 miles (1,600 km)	6.25 (10)	12.5 (20)	18.75 (30)	25 (40)	31.25 (50)	37.5 (60)	43.75 (70)	50 (80)	56.25 (90)	62.5 (100)	
		6	12	18	24	30	36	42	48	54	60		
A road test must be performed after maintenance service is completed		I	I	I	I	I	I	I	I	I	I	I	I

Abbreviation: I: Inspect, correct-replace if necessary

The above charts show the normal maintenance schedule. Depending upon weather and atmospheric conditions, varying road surfaces, individual driving habits and vehicle usage, additional or more frequent maintenance may be required.

FOREWORD

Description

The control of automotive air pollution largely depends upon the development of effective emission control systems. To meet this demand, NISSAN has been making consistent and continuous efforts towards the further development of such devices.

Your DATSUN is equipped with emission control systems that are designed and built in accordance with the Federal Clean Air Act. These systems provide the proper emission performance under normal use when serviced at regular intervals.

Under the laws of some states in the U.S.A. and provinces of Canada, the owner is subject to penalties for any modification to the emission control systems after delivery.

Warranty Statement

The emission control system warranty is described in your Guarantee and Service Booklet.

Owner's Responsibility for Documentation

Federal Regulations provide that the emission system warranty is valid only when the systems are maintained in accordance with the manufacturer's maintenance instruc-

tions. Accordingly, records in the form of receipts, invoices or signed coupons must be maintained as proof of compliance.

For your convenience, the coupons in the Guarantee and Service Booklet have been designed to incorporate the signature of your authorized NISSAN/DATSUN dealer upon completion of the required maintenance service. This signed coupon is proof of compliance and should be kept in the glove box.

All receipts, along with the Guarantee and Service Booklet should be transferred to each subsequent owner of the vehicle.

Normal Vehicle Use

The emission standards may be satisfied by having the vehicle inspected periodically and by meeting the requirements listed below:

- (1) The vehicle should be operated within the prescribed passenger and load limitations. Especially in the case of a Pick-up, the owner should strictly adhere to follow the instructions printed on the label affixed to the vehicle.
- (2) Use an unleaded or low-lead gasoline with a minimum octane rating of 91 RON (Research Octane Number).

Emission Control Systems

- (3) For vehicles equipped with catalytic converters to meet the State of California regulations be sure to use only unleaded gasoline to protect the catalytic converter from contamination.
- (4) The vehicle should always be maintained in accordance with the specifications stipulated by NISSAN.

Recommendation of Genuine NISSAN Parts in Required Maintenance

The emission control system on your NISSAN vehicle is designed, built and tested in accordance with Federal and some State Regulations.

To assure the best results and to maintain the original quality built into the systems, it is recommended that genuine NISSAN parts be used when servicing the system. The use of replacement parts which are inferior to genuine NISSAN parts may reduce the effectiveness of the system.

Therefore, if it becomes necessary to utilize other than genuine NISSAN parts, the owner should make certain that such parts are warranted by their manufacturer to be equivalent to genuine NISSAN parts in quality.

EMISSION CONTROL SYSTEM

The new DATSUN 280Z employs several emission control systems in addition to the electronic fuel injection system, with a view to satisfying all the applicable regulations for automotive emission control.

With this emission control system built into DATSUN, the discharge of pollutants has been reduced substantially.

These pollutants are primarily hydrocarbons, nitrogen oxides and carbon monoxide.

Hydrocarbons and nitrogen oxides when exposed to sunlight under certain conditions produce photochemical smog.

Carbon monoxide is toxic when highly concentrated in the air.

The emission control system consists of (1) crankcase emission control system (2) exhaust emission control system, and (3) evaporative emission control system.

The crankcase emission control system recirculates blow-by gases to the combustion chamber and prevents the emission of such unburnt gases into the air.

The exhaust emission control system insures that fuel is burned completely and properly. The evaporative emission control system prevents evaporative gases from escaping into the air. These

systems are outlined below.

On models destined for sale in California, a catalytic converter has been installed in order to meet the emission standards applicable only in California.

1. CRANKCASE EMISSION CONTROL SYSTEM

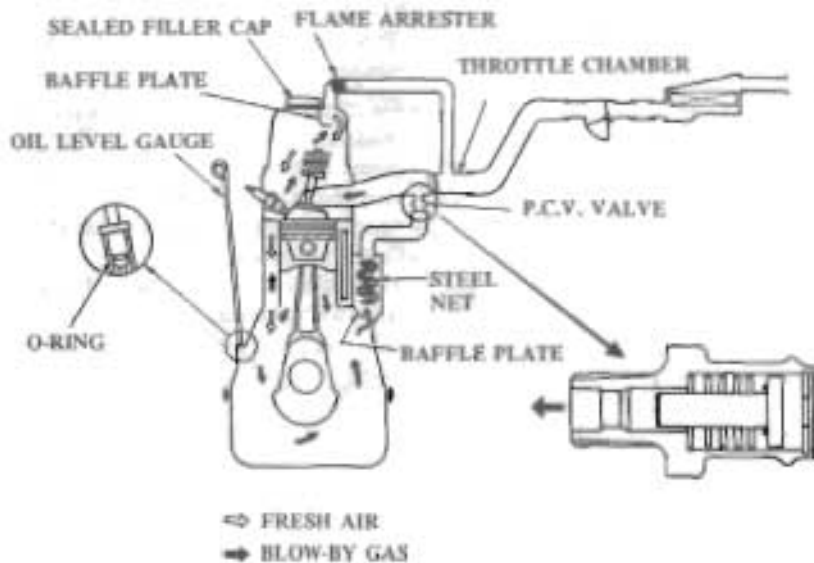

Emission Control Systems

This system is designed to send blow-by gases back to the combustion chamber for reburning, and at the same time to send filtered air into the crankcase for ventilation. Thus, it serves to prevent the emission of blow-by gases into the atmosphere.

The function of this system depends upon the positive crankcase ventilation (P.C.V.) control valve which returns blow-by gases to the combustion chamber.

2. EXHAUST EMISSION CONTROL SYSTEMS

There is a considerable difference between the exhaust emission control system for California and that for other areas.

The system on models destined for sale in California employs a catalytic converter.

This system includes the following components.

- 1) Electronic Fuel Injection System (All models)
- 2) Boost Controlled Deceleration Device (B.C.D.D.) (All models)
- 3) Spark Timing Control System (Non-California models only)
- 4) Transmission Controlled Vacuum Advance (Manual transmission models only) (Non-California models only)
- 5) Exhaust Gas Recirculation (E.G.R.) System (California models only)
- 6) Catalytic Converter (California models only)

1) Electronic Fuel Injection System (All models)

The electronic fuel injection system monitors the operating conditions of the engine through various types of sensors. The electrical signals transmitted from the sensors enter the control unit where the correct injection open-valve time period is computed on the basis of preset conditions for optimum fuel injection.

This system permits operation of the car with lean air-fuel mixture, and improves exhaust performance and fuel economy.

Emission Control Systems

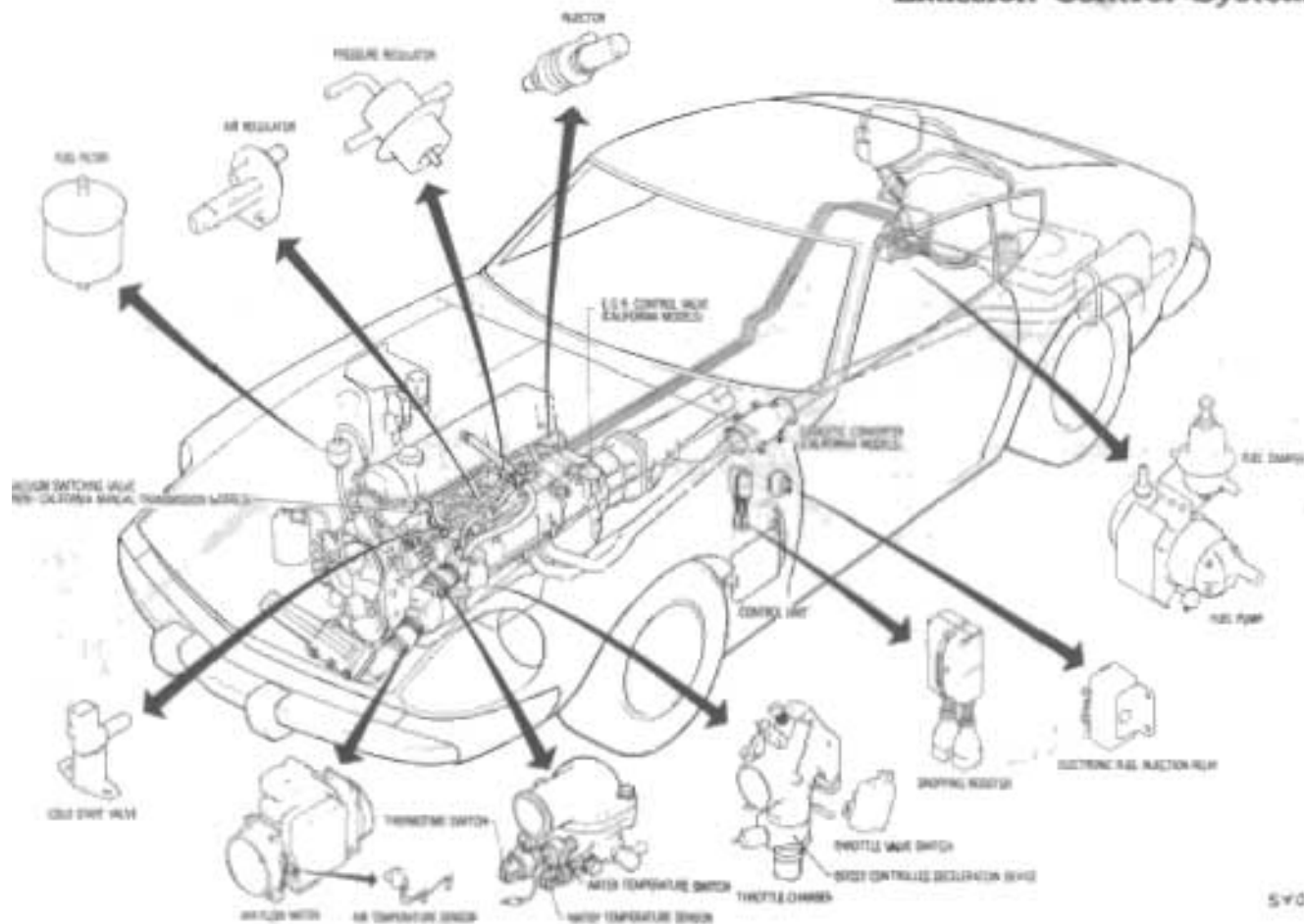

5-V025

Emission Control Systems

2) Boost Controlled Deceleration Device (B.C.D.D.) (All models)

The B.C.D.D. is mounted on the bottom of the throttle chamber. The B.C.D.D. function is to open an air passage which bypasses the throttle valve during deceleration.

During deceleration, the air-fuel mixture ratio becomes unbalanced and normal combustion cannot continue.

Thus, a great amount of unburned hydrocarbons are emitted.

The B.C.D.D. supplies additional air into the intake manifold to balance the air-fuel mixture ratio and prevent such unburned hydrocarbons from being emitted.

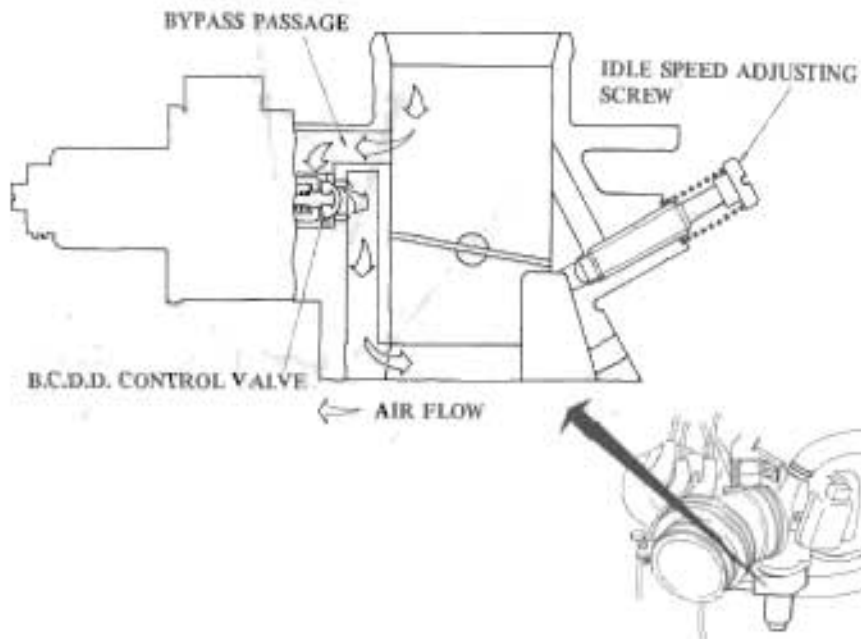

SY030

3) Spark Timing Control System (Non-California models only)

This system is installed only on non-California models.

It is designed to automatically advance or retard the spark timing to meet all vehicle conditions.

Advanced spark timing occurs only at low engine coolant temperatures; this assures driveability.

This system consists of a water temperature switch, a relay, a dual pick-up coil type distributor and a transistor ignition unit.

The switch monitors engine coolant temperature and the relay switches spark timing between the Advanced and Retarded positions.

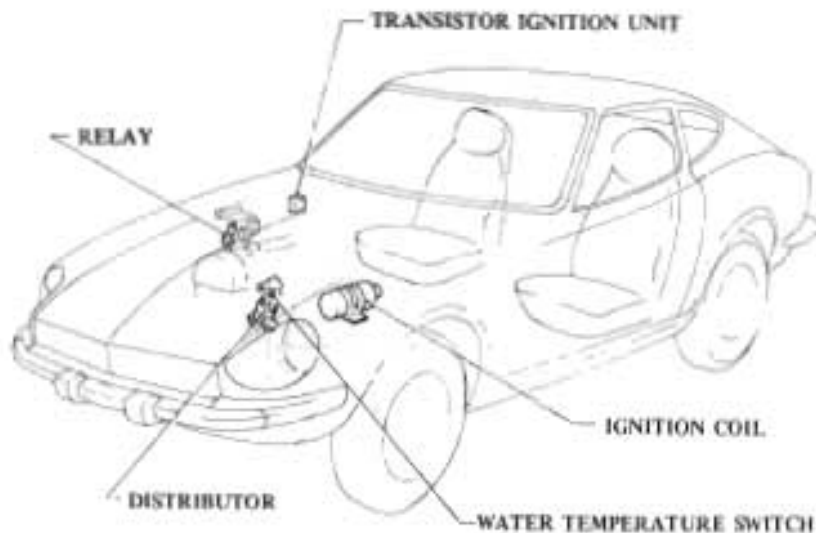

8Y031

Emission Control Systems

4) Transmission Controlled Vacuum Advance (Manual transmission models only) (Non-California models)

The system provides the vacuum advance only when the gear is shifted to the Top (4th) position; it provides retarded spark timing (with no vacuum advance) at other positions.

The controls used in this system are shown in the illustration below.

Note: The Top (4th) detecting switch actuates only when the transmission is shifted to 4th gear.

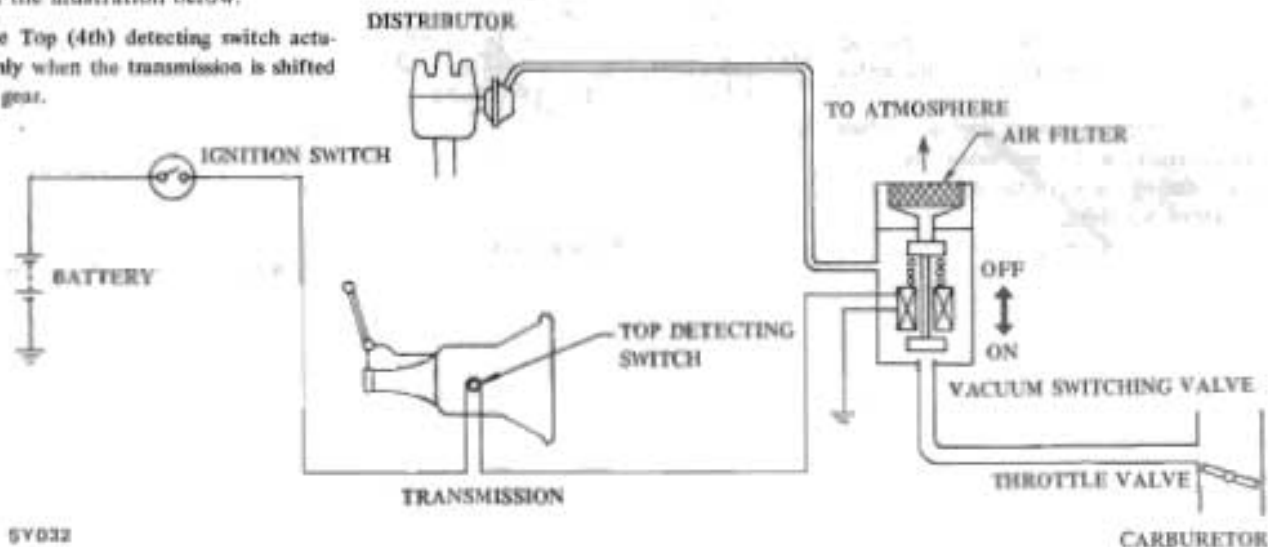

5V032

5) Exhaust Gas Recirculation (E.G.R.) System (California models only)

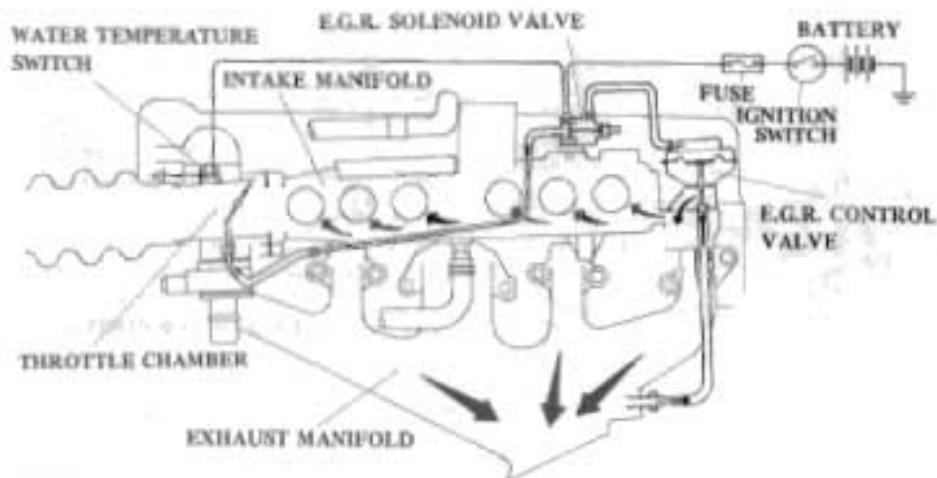

5V033

The purpose of the E.G.R. system is to direct burnt gases into the intake manifold so that they re-enter the engine combustion chambers.

This system controls the engine combustion temperature, thus reducing NOx emission. Proper operation of this system depends upon an E.G.R. control valve and a water temperature switch. When the engine is warmed up, the vacuum built up in the carburetor actuates the E.G.R. control valve through the water temperature switch.

The spent gas is then led from the exhaust manifold into the intake manifold through the E.G.R. control valve.

The solenoid valve and water temperature switch inactivate the system when the engine coolant temperature is low, providing good driveability and easy starting in cold weather.

Emission Control Systems

6) Catalytic Converter (California models only)

The catalytic converter is installed only on California models. It is located midway along the exhaust tube, where the primary muffler is installed on non-California models. This converter promotes the oxidization of HC and CO, thereby substantially reducing CO and HC emissions.

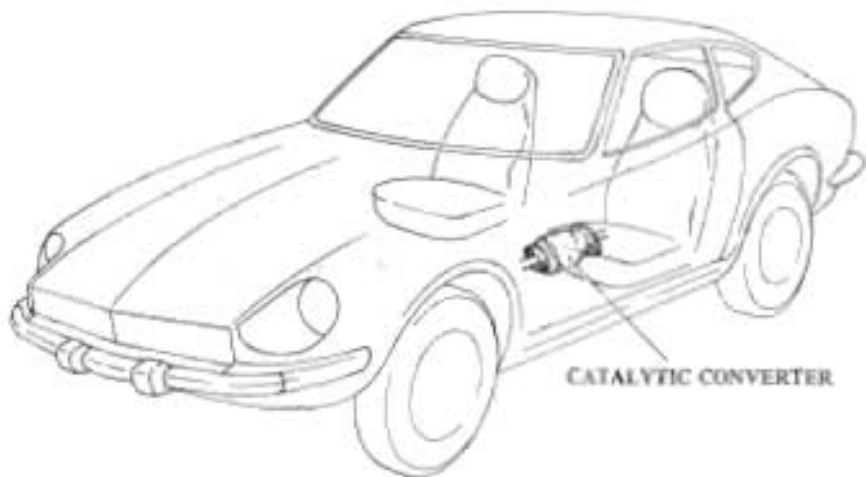

5Y034

3. EVAPORATIVE EMISSION CONTROL SYSTEM

The evaporative emission control system prevents evaporative gases in the fuel tank from entering the atmosphere. When the vacuum pressure in the fuel tank is too high, air passes through the vacuum relief valve in the fuel filler cap.

At the same time, the fuel filler cap prevents evaporative gases from being expelled into the atmosphere.

Therefore, evaporative gases are stored in the carbon canister.

When the engine is running, the stored evaporative gases are sucked into the intake manifold.

A filter which is vented to the atmosphere is located on the bottom of the carbon canister. When the evaporative gases inside the carbon canister are sucked into the carburetor, air is sucked through the filter element and then passes through the activated carbon.

This intake of air cleans the activated carbon and prevents decompression in the fuel tank.

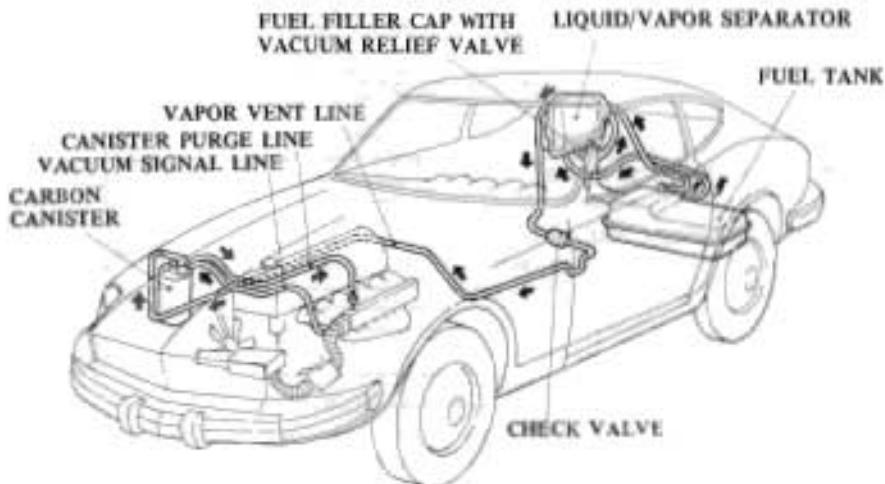

5V035

Emission Control Systems

EMISSION CONTROL MAINTENANCE SCHEDULE

MAINTENANCE OPERATION <small>(Periodic maintenance should be performed at number of miles, kilometers or months, whichever comes first)</small>	Number of miles in thousands Number of kilometers in thousands Number of months	MAINTENANCE INTERVAL				
		1,000 miles (1,600 km)	13.5	25	37.5	50
			20	40	60	80
		12	24	36	48	
1. Intake & exhaust valve clearance		A	A	A	A	A
2. Drive belts		A	I	I	I	I
3. Cylinder head bolts, manifold nuts & throttle chamber securing nuts		A				
4. Engine oil & oil filter	(1)	R	R: 8,250 mile (13,000 km) interval			
5. Engine coolant				R		R
6. Cooling system hoses & connections			I	I	I	I
7. Vacuum fitting hoses & connections			I	I	I	I
8. Idle rpm		A	A	A	A	A
9. Air regulator hoses		I	I	I	I	I
10. Base controlled deceleration device		I	I	I	I	I
11. Fuel filter	(2)			R		R
12. Fuel leaks (hoses, piping, connections, etc.)		I	I	I	I	I
13. Air cleaner filter	(2)			R		R
14. Ignition timing			A	A	A	A
15. Spark plugs			R	R	R	R
16. Distributor cap & rotor			I	I	I	I
17. Operating parts of distributor & ignition wiring						I
18. Vacuum switching valve (non-California model/transmission models only)						I
19. Positive crankcase ventilation (P.C.V.) valve				R		R
20. Ventilation hoses				I		I
21. Vapor lines			I	I	I	I
22. Fuel tank vacuum relief valve		I		I		I
23. Carbon canister filter				R		R
24. Cable harness & connectors				I		I

NOTE: (1) If vehicle is operated under severe service conditions: short distance driving, extensive idling or driving in dusty conditions, change engine oil every 3,000 miles (5,000 km) or 3 months, whichever comes first.
(2) More frequent maintenance if under dusty driving conditions.

NOTICE: A = Adjust R = Replace I = Inspect, Correct-Replace if necessary

INSTRUCTIONS FOR EMISSION CONTROL MAINTENANCE SERVICE

These scheduled maintenance services should be performed at the designated service intervals in order to ensure good emission control performance and good engine performance in your new DATSUN.

THE FIRST 1,000 MILE (1,600 KM) SERVICE IS ONE OF THE MOST IMPORTANT SERVICES REQUIRED TO ENSURE THE MAXIMUM EMISSION CONTROL PERFORMANCE AND OPTIMUM ENGINE CONDITION OF YOUR NEW DATSUN.

It is also important that emission control components be replaced at the designated time or mileage. If frequently used under unusual operating conditions (driving on dusty roads, disuse for long periods of time, repeated travel of less than several miles, short trips in freezing temperatures, or towing a trailer), the car might require ad-

ditional maintenance. For example, increased frequency of air cleaner filter replacement, cleaning or replacement of spark plugs, or changing of the oil and oil filter may become necessary.

If maintenance service is required, or if your car begins to malfunction, or if the idle-adjustment is not correct, have the systems checked and tuned by an authorized NISSAN/DATSUN dealer or any other qualified service outlet.

SERVICE NOTICE: (California models only)

When making an emission test, be sure to remove the exhaust diffuser before inserting the rubber sampling hose into the exhaust pipe.

Emission Control Systems

1976 Maintenance Instructions

(1) Intake and exhaust valve clearance

Proper adjustment of the valve clearance is essential to exhaust emission control.

Be sure that this adjustment is correct or valve noise or unstable idling may occur.

(2) Drive belts

Check drive belts for wear, fraying or cracking and proper tension.

To check the proper tension of the drive belts, depress the belt at the recommended position to the specified value and observe the slack in the belt.

Replace the drive belts if found damaged.

(3) Cylinder head bolts, manifold nuts and throttle chamber securing nuts

The above bolts and nuts should be correctly retightened to prevent air and/or exhaust gas leakage.

(4) Engine oil and oil filter

Engine oil and oil filter should be changed after the first 1,000 miles

Emission Control Systems

(1,600 km) and every 6,250 miles (10,000 km) or 6 months, whichever comes first.

(5) Engine coolant

The engine coolant should be checked for proper level.

Engine coolant including permanent anti-freeze coolant (Ethylene-Glycole base) should be changed every 25,000 miles (40,000 km) or 24 months, whichever comes first.

Whenever the coolant is changed, the cooling system must be flushed and refilled.

(6) Cooling system hoses and connections

Check the cooling system, hoses and connections for damage or looseness.

If a leaky hose or connection is found, replace it.

(7) Vacuum fitting hoses and connections

Check hoses and connections for looseness or damage.

If a deteriorated or damaged hose is found, replace it.

(8) Idle rpm

Using a tachometer, adjust the idling speed of the engine correctly. This engine is equipped with an electronic fuel injection system, and therefore requires no adjustment for air-fuel mixture ratio.

(9) Air regulator hoses

Check the air regulator hoses for correct insertion, cracks, damage, or clogging. If any hose is found faulty, replace it.

(10) Boost controlled deceleration device

Raise engine speed and then reduce it to idling speed.

Check the operating pressure of the B.C.D.D. and confirm that the engine drops to idling speed properly.

Adjust the operating pressure or replace if necessary.

(11) Fuel filter

The fuel filter should be changed every 25,000 miles (40,000 km) or 24 months, whichever comes first.

(12) Fuel lines (hoses, piping, connections, etc.)

Check the fuel hoses, piping and connections for leak, looseness or deterioration. Replace any parts if they are damaged.

(13) Air cleaner filter

Under normal driving conditions, the air cleaner filter should be replaced every 25,000 miles (40,000 km) or 24 months, whichever comes first.

However, driving the car in dusty areas will cause rapid clogging of the element. Consequently, the element may have to be replaced more frequently.

(14) Ignition timing

Ignition timing must be adjusted with the proper equipment.

(15) Spark plugs

The spark plugs should be replaced every 12,500 miles (20,000 km) or 12 months, whichever comes first.

(16) Distributor cap and rotor

Check the distributor cap and rotor for cracks, carbon formation or erosion.

The rotor head and the inside of distributor cap should be cleaned.

(17) Operating parts of distributor and ignition wiring

The mechanical and vacuum advance mechanisms should be checked for proper connection of the governor spring and breaker plate operation.

Check the ignition wiring for cracking of exterior insulation and for proper fit on the distributor cap and spark plugs.

(18) Vacuum switching valve (non-California manual transmission models only)

This valve is actuated by the shift position of the transmission.

Check for proper operation of vacuum switching valve.

(19) Positive crankcase ventilation (P.C.V.) valve

The P.C.V. valve should be replaced every 25,000 miles (40,000 km) or 24 months, whichever comes first.

(20) Ventilation hoses

The ventilation hose should be blown out with air to make certain that it is clean when the P.C.V. valve is replaced.

Insure that the flame arrester is securely inserted in the hose between the rocker cover and T-connector.

(21) Vapor lines

Check vapor lines and connections for failure or looseness.

If leaks are found, replace them.

(22) Fuel tank vacuum relief valve

A damaged vacuum relief valve may sometimes leak evaporative gas or cause

fuel tank deformation. If replacement of the valve becomes necessary, replace the fuel filler cap assembly.

(23) Carbon canister filter

The carbon canister filter should be replaced every 25,000 miles (40,000 km) or 24 months, whichever comes first.

Make sure that the filter element is positioned on the bottom of the carbon canister.

(24) Cable harness and connectors

Check the harness connectors for correct insertion, and the harness connector terminals for deformation or rust. Replace any parts found faulty.

Emission Control Systems

EMISSION CONTROL TROUBLE SHOOTING CHART

The chart shown below will be extremely helpful in trouble shooting the emission control system of your Datsun. Whenever the condition of any part of the emission control system is questionable, utilize this chart as a guide to locate and correct the cause of trouble.

Satisfactory performance and operation of the emission control system are assured only when the system is properly cared for.

Notes:

- Before checking or repairing any part of the emission control system, ensure that all safety precautions are taken.
- Idling and ignition timing adjustments require the use of special equipment or instruments.

Condition	Probable cause	Corrective action
Engine will not crank or cranks very slowly.	Discharged or damaged battery. Loose connection. <ul style="list-style-type: none"> ● Battery ● Starter Damaged starter motor. Malfunction in electronic fuel injection system.	Charge or replace. Check both cable connections on battery and grounded end. Check connections at magnetic switch mounted on starter. Repair or replace. Replace.
Engine will crank normally but will not start.	Ignition system Loose connection in ignition system.	Check for loose connections at ignition coil, distributor and spark plugs.

Condition	Probable cause	Corrective action
	<p>Weak spark or no spark occurs on spark plugs.</p> <p>Test procedure</p> <p>Disconnect high tension cable from one spark plug and hold it about 0.4 inch (10 mm) from the engine block and crick engine.</p> <p>Note: Hold high tension cable with dry piece of cloth.</p> <p>Fuel system</p> <p>No fuel in fuel line.</p> <p>Clogged fuel line.</p> <p>Malfunction in pressure regulator.</p> <p>Malfunction in electronic fuel injection system.</p>	<p>If good spark occurs.</p> <p>Check spark plugs and clean or replace.</p> <p>Check fuel system and clean or repair.</p> <p>Check ignition timing.</p> <p>Check cylinder compression.</p> <p>If weak spark or no spark occurs.</p> <p>Check and clean distributor cap and rotor.</p> <p>Check ignition system.</p> <p>Check that there is still fuel in fuel tank. Refill if necessary.</p> <p>Check fuel pump.</p> <p>Check for clogged fuel strainer and piping.</p> <p>Check pressure regulator, replace if necessary.</p> <p>Replace.</p>
High engine idle speed.	<p>Binding accelerator linkage.</p> <p>Malfunctioning B.C.D.D. system.</p>	<p>Check and correct accelerator linkage.</p> <p>If engine idling speed rises above 1,800 to 2,000 rpm, the cause may be a malfunctioning B.C.D.D. system.</p>

Emission Control Systems

Condition	Probable cause	Corrective action
	<p>Malfunctioning air regulator.</p> <p>Incorrect adjustment of idle speed adjusting screw.</p>	<p>Check B.C.D.D. system. Repair or replace if necessary. Replace.</p> <p>Correct.</p>
<p>Rough or unstable engine idle.</p>	<p>Improper valve clearance.</p> <p>Incorrect idle adjustment.</p> <p>Clogged air cleaner filter.</p> <p>Malfunction in E.G.R. control valve.</p> <p>Loose manifold and cylinder head bolts.</p> <p>Damaged or disconnected carbon canister purge line hose.</p> <p>Damaged or disconnected crankcase ventilation hoses.</p> <p>Malfunction in pressure regulator.</p> <p>Malfunction in electronic fuel injection system.</p>	<p>Adjust valve clearance.</p> <p>Adjust idle speed.</p> <p>Replace air cleaner filter.</p> <p>Clean or replace.</p> <p>Retighten bolt.</p> <p>Connect or replace.</p> <p>Connect or replace.</p> <p>Replace.</p> <p>Replace.</p>
<p>Engine knocking.</p>	<p>Use of fuel with insufficient octane rating.</p>	<p>Change to recommended fuel. Check ignition timing if necessary.</p>

Emission Control Systems

Condition	Probable cause	Corrective action
	Laboring engine. Improper distributor or water temperature switch.	Select a lower gear. Repair or replace.
Backfire or after fire.	Irregular combustion. Damaged E.G.R. control valve. Malfunction in electronic fuel injection system.	Check spark plugs for gap, carbon deposit or incorrect heat range. Check ignition timing. Replace. Replace.
Charge warning light comes on while driving.	Loose connection. Loose fan belt. Damaged alternator or voltage regulator.	Check for loose connections of alternator and voltage regulator. Adjust belt tension. Repair or replace alternator or voltage regulator.
Floor temperature too high (California only) (Refer to the Starting and Operating section.)	Damaged heat insulator. Problem in fuel or ignition system.	Check and replace. Check the systems. Replace damaged parts.

Specifications

1. Engine Number

The engine number is stamped on the right side of the cylinder block.

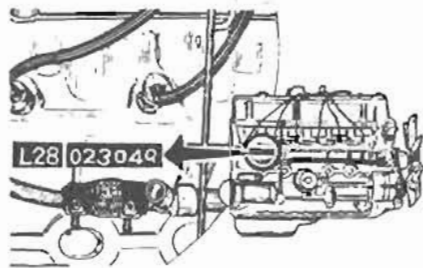

4. Car Serial Number

The car serial number is stamped on the upper face of the left dash panel.



SP057

2. Identification Number

The identification number is stamped on instrument panel.

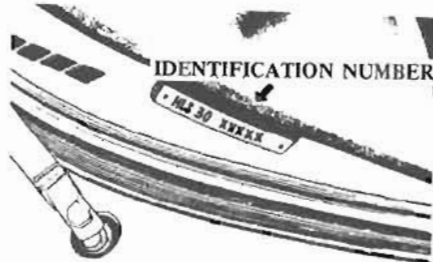

5. Certification and Information Label Location

The M.V.S.S. certification and Vehicle emission control information labels are affixed to the upper portion of the left lock pillar.

VEHICLE
EMISSION
CONTROL
INFORMATION
LABEL



CERTIFICATE
LABEL

SP058

3. Car Identification Plate

The car identification plate is located on the left hoodedge panel at the back of strut housing.

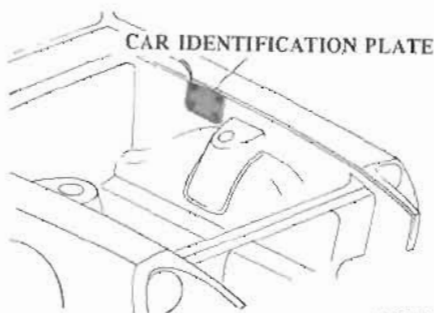

SP053

CAR SPECIFICATIONS

CAR MODEL	HLS30	GHLS30
DIMENSIONS		
Overall length	in (mm)	173.2 (4,400) 185.4 (4,710)
Overall width	in (mm)	64.2 (1,630) 65.0 (1,650)
Overall height	in (mm)	51.0 (1,295) 51.4 (1,306)
Wheelbase	in (mm)	90.7 (2,304) 102.6 (2,606)
SEATING CAPACITY	2	2+2
WEIGHT		
Gross Vehicle Weight Rating (G.V.W.R.)		
Non-California	lb (kg)	3,185 (1,445) 3,585 (1,626.2)
California	lb (kg)	3,203 (1,452) 3,603 (1,634.3)
Gross Axle Weight Rating (G.A.W.R.)		
Front Non-California	lb (kg).....	1,468 (666) 1,603 (727)
California	lb (kg)	1,477 (670) 1,612 (731)
Rear Non-California	lb (kg)	1,717 (779) 1,982 (899)
California	lb (kg)	1,726 (783) 1,991 (903)

Specifications

ENGINE SPECIFICATIONS

Design	L28, 6 cylinder in-line, O.H.C. Electronic Fuel Injection System
Displacement cu in (cc)	168.0 (2,753)
Bore x Stroke in (mm)	3.39 x 3.11 (86 x 79)
Compression ratio	8.3 : 1
Ignition timing (B.T.D.C.)	
Non-California	
Automatic transmission	7°/700 rpm (Retarded) } in "D"
Manual transmission	*13°/700 rpm (Advanced) } position
California	
Automatic transmission	7°/800 rpm (Retarded) }
Manual transmission	*13°/800 rpm (Advanced) } in "D"
Automatic transmission	10°/700 rpm in "D" position
Manual transmission	10°/800 rpm
Idling speed	
Automatic transmission	700 rpm in "D" position
Manual transmission	800 rpm
Battery	12V-65AH
Spark plug gap in (mm)	0.028 to 0.031 (0.7 to 0.8)
Distributor air gap in (mm)	0.008 to 0.016 (0.2 to 0.4)

* : After engine is warmed up ignition timing is retarded.
Advanced ignition timing adjustment is necessary only when adjusting phase difference.

Valve clearance (Cold)

Intake in (mm) 0.0079 (0.20)

Exhaust in (mm) 0.0098 (0.25)

Belt tension

Fan belt in (mm) 0.31 to 0.47 (8 to 12)

Cooler compressor belt in (mm) 0.31 to 0.47 (8 to 12)

Specifications

Approximate refill capacities

		U.S. Measure	Imper. Measure	Liters	
Fuel tank	Fuel	17 $\frac{1}{4}$ gal.	14 $\frac{3}{8}$ gal.	65	
Engine cooling system	Coolant	11 qt.	9 $\frac{1}{2}$ qt.	10.4	
Engine crankcase *	Engine oil	5 qt.	4 $\frac{1}{2}$ qt.	4.7	
Transmission case	Manual	Gear oil	3 $\frac{3}{8}$ pt.	2 $\frac{7}{8}$ pt.	1.6
	Automatic		5 $\frac{7}{8}$ qt.	4 $\frac{7}{8}$ qt.	5.5
Differential case			2 $\frac{3}{4}$ pt.	2 $\frac{1}{4}$ pt.	1.3

* Includes 1 $\frac{1}{2}$ U.S. pt. (1 $\frac{1}{4}$ Imper. pt., 0.7 liter) required for oil filter replacement.

INTRODUCTION

The figures contained in the summary following apply to all NISSAN/DATSUN vehicles in the particular group.

In compliance with the National Traffic and Motor Vehicles Safety Act (15 U.S.C. 1401, 1407), our NISSAN/DATSUN vehicles have been tested extensively and the results compiled to cover completely our total range of automobiles.

It is essential, we feel, that our users should carefully study the data before driving their new NISSAN/DATSUN so that they are familiar with the potential ability of the vehicle **PRIOR** to using it.

The U.S. Federal Government's Road Traffic Authority has carefully evaluated the statistics relating to the following minimum safety figures and has laid down specific guidelines that we, the manufacturers, must use when arriving at the figures stated in the following pages.

We at Nissan Motor Company of Tokyo, Japan, would like to state that the following figures are accurate and representative but in the event of drivers **NOT** following our recommendations regarding servicing, tire pressures, etc., we cannot accept responsibility for any injuries, damage, etc., apart from the parts covered under the usual Nissan Guarantee which **SPECIFICALLY** states that our recommended procedures must be followed carefully in order to validate the guarantee.

Consumer Information

VEHICLE STOPPING DISTANCE

This figure indicates braking performance that can be met or exceeded by the vehicles to which it applies, without locking the wheels, under different conditions of loading and with partial failures of the braking system. The information

presented represents results obtainable by skilled drivers under controlled road and vehicle conditions, and the information may not be correct under other conditions.

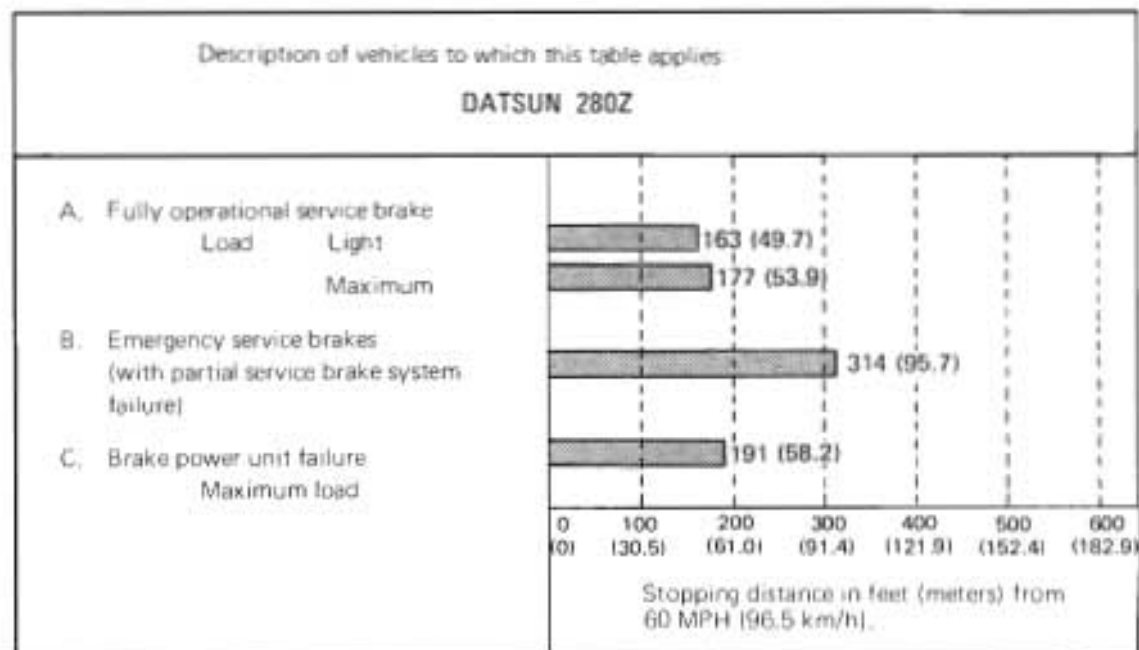

Description of vehicles to which this table applies:

DATSUN 280Z 2+2

A. Fully operational service brake

Load Light

188 (57.3)

Maximum

181 (55.2)

B. Emergency service brakes

(with partial service brake system failure)

337 (102.7)

C. Brake power unit failure

Maximum load

230 (70.1)

0	100	200	300	400	500	600
(0)	(30.5)	(61.0)	(91.4)	(121.9)	(152.4)	(182.9)

Stopping distance in feet (meters) from
60 MPH (96.5 km/h).

Description of vehicles to which this table applies				
DATSUN 280Z 2+2				
Recommended tire size designations		175HR14	195/70HR14	
Recommended cold inflation pressure for maximum loaded vehicle weight psi (kg/cm ²)	Front	28 (2.0)	28 (2.0)	
	Rear	28 (2.0)	28 (2.0)	
Tire reserve load percentage *		12.7	18.4	

- * The difference, expressed as a percentage of tire load rating, between (a) the load rating of a tire at the vehicle manufacturer's recommended inflation pressure at the maximum loaded vehicle weight and (b) the load imposed upon the tire by the vehicle at that condition.

Warning: Failure to maintain the recommended tire inflation pressure or to increase tire pressure as recommended when operating at maximum loaded vehicle weight, or loading the vehicle beyond the capacities specified on the tire placard affixed to the vehicle, may result in unsafe operating conditions due to premature tire failure, unfavorable handling characteristics, and excessive tire wear. The tire reserve load percentage is a measure of tire capacity, not of vehicle capacity. Loading beyond the specified vehicle capacity may result in failure of other vehicle components.

Consumer Information

ACCELERATION AND PASSING ABILITY

This figure indicates passing times and distances that can be met or exceeded by the vehicles to which it applies, in the situations diagrammed below.

The low-speed pass assumes an initial speed of 20 MPH (32.2 km/h) and a limiting speed of 35 MPH (56.3 km/h). The high-speed pass assumes an initial speed of 50 MPH (80.5 km/h) and a limiting speed of 80 MPH (128.7 km/h).

Notice: The information presented represents results obtainable by skilled drivers under controlled road and vehicle conditions, and information may not be correct under other conditions.

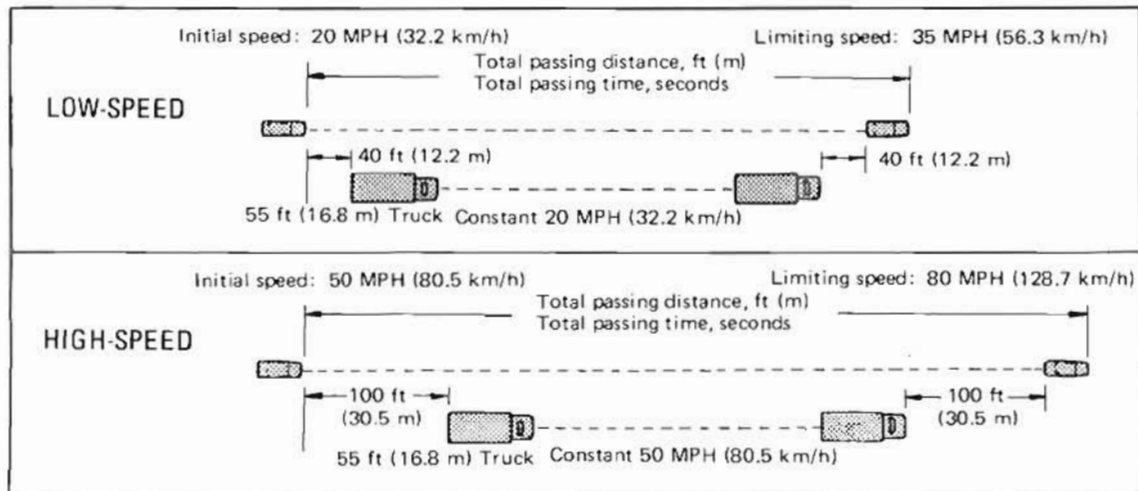

Consumer Information

DATSUN 280Z

Low-speed pass 370 feet (112.8 m); 7.6 seconds
High-speed pass ... 1,150 feet (350.5 m); 12.0 seconds

DATSUN 280Z

with Air Conditioner

Low-speed pass 375 feet (114.3 m); 7.7 seconds
High-speed pass ... 1,190 feet (362.7 m); 12.5 seconds

DATSUN 280Z

with Automatic Transmission

Low-speed pass 405 feet (123.4 m); 8.7 seconds
High-speed pass ... 1,220 feet (371.9 m); 13.0 seconds

DATSUN 280Z

with Automatic Transmission &
Air Conditioner

Low-speed pass 405 feet (123.4 m); 8.8 seconds
High-speed pass ... 1,260 feet (384.0 m); 13.5 seconds

Consumer Information

DATSUN 280Z 2+2

Low-speed pass 380 feet (115.8 m); 7.8 seconds
High-speed pass ... 1,220 feet (371.9 m); 13.0 seconds

DATSUN 280Z 2+2

with Air Conditioner

Low-speed pass 380 feet (115.8 m); 7.9 seconds
High-speed pass ... 1,260 feet (384.0 m); 13.5 seconds

DATSUN 280Z 2+2

with Automatic Transmission

Low-speed pass 415 feet (126.5 m); 9.0 seconds
High-speed pass ... 1,300 feet (396.2 m); 14.0 seconds

DATSUN 280Z 2+2

with Automatic Transmission &
Air Conditioner

Low-speed pass 415 feet (126.5 m); 9.1 seconds
High-speed pass ... 1,330 feet (405.4 m); 14.5 seconds

NOTES:

Original Owner's Name: Phone Number:

Owner's Address:

Purchase Date:

Dealer's Name: Phone Number:

Dealer's Address:

Car Model: Color:

Car Number:

Engine Number:

Registration Number: Key Number:

Subsequent Owner's Name: Phone Number:

Owner's Address:

Purchase Date:

Mileage shown on Speedometer on Day of Purchase:

.....

.....

.....

.....

Index

- ACCELERATION AND PASSING ABILITY 96, 97, 98
ACCELERATOR PEDAL 11
AIR CONDITIONER 36, 37
APPROXIMATE REFILL CAPACITIES 90
ASH TRAYS 11, 39
AUTOMATIC TRANSMISSION FLUID 54
BAGGAGE STRAPS 42
BATTERY 31, 54
BATTERY ELECTROLYTE LEVEL 50
BRAKE AND CLUTCH FLUID LEVEL 49, 50
BRAKE PEDAL 11
BRAKE WARNING LIGHT 15
BREAK-IN SCHEDULE 21
BULB REPLACEMENT 57, 58
BULB SPECIFICATIONS 56
CAR EQUIPPED WITH CATALYTIC CONVERTER 22, 23
CAR IDENTIFICATION PLATE 86
CAR SERIAL NUMBER 86
CAR SPECIFICATIONS 87
CATALYTIC CONVERTER SYSTEM 3, 22, 23, 76
CERTIFICATION AND INFORMATION LABEL
 LOCATION 86
CHANGING TIRES 60, 61
CHANGING WHEELS 61
CHARGE WARNING LIGHT 14
CIGARETTE LIGHTER 11, 38
CLEANING YOUR CAR 63, 64
CLOCK 11, 38
CLUTCH PEDAL 11
COAT HANGER (280Z model) 40
DASH SIDE VENTILATOR KNOB 11, 20
DOOR LOCKS 5
DRIVING WITH AUTOMATIC TRANSMISSION 27, 28
DRIVING WITH MANUAL TRANSMISSION 26, 27
EMISSION CONTROL MAINTENANCE
 SCHEDULE 78
EMISSION CONTROL SYSTEM 69 to 77
EMISSION CONTROL TROUBLE SHOOTING
 CHART 82 to 85
ENGINE COOLANT LEVEL 49
ENGINE NUMBER 86
ENGINE OIL LEVEL 48
ENGINE OIL RECOMMENDATION 52
ENGINE SPECIFICATIONS 88, 89
FLOOR TEMPERATURE WARNING
 LIGHT 11, 16, 22, 23
FOLDING REAR SEAT (280Z 2+2 model) 42
FOOT REST 11, 41
FRILING IMMOBILIZED CAR 44
FUEL FILLER LID 6
FUEL GAUGE 12
FUEL RECOMMENDATION 53
FUEL WARNING LIGHT 11, 14
FUSES 55
GAS STATION INFORMATION Back covered page
GLOVE BOX 11
GLOVE BOX LIGHT 40
HAZARD WARNING 44
HAZARD WARNING FLASHER SWITCH 11, 19
HEATER 11, 34, 35, 36
HIGH BEAM INDICATOR LIGHT 15
HOOD LOCK 11, 53
HORN 11, 19
IDENTIFICATION NUMBER 86
IGNITION SWITCH AND STEERING
 LOCK 5, 11, 24, 25
ILLUMINATION CONTROL 11
ILLUMINATION CONTROL RHEOSTAT 18
INSPECTION LIGHT 43
INSTRUCTIONS FOR EMISSION
 CONTROL MAINTENANCE SERVICE 79, 80, 81
INTERIOR LIGHT 39
JUMP STARTING WITH BOOSTER BATTERY 45
KEY
 Door locks 5
 Glove compartment lock 5
 Ignition switch and steering lock 5, 11, 24, 25
 Tailgate lock 5, 42
LIGHT SWITCH 11, 17
MAP LIGHT 11, 40
MINOR MAINTENANCE 53 to 58
OIL AND FUEL RECOMMENDATION 52
OIL PRESSURE GAUGE 11, 13
OPENING THE HOOD 47
OPENING THE INSPECTION LID 48
PARKING BRAKE LEVER 11, 20
PARKING BRAKE WARNING LIGHT 15
PERIODIC MAINTENANCE AND LUBRICATION
 SCHEDULE 65, 66
PUSH STARTING 45
RADIO 11, 37, 38
REAR DEFOGGER INDICATOR LIGHT 11
REAR SEAT STRAP (280Z 2+2 model) 41
REARVIEW MIRRORS 10
REAR WINDOW ELECTRIC DEFROSTER
 SWITCH 11, 19
RECOMMENDED LUBRICANT SPECIFICATIONS 53
RECOMMENDED SAE VISCOSITY NUMBER 52
ROUTINE SERVICE 48 to 51
SAFETY CHECKS 4
SAFETY SEAT BELT 2, 8, 9
SEAT BELT WARNING LIGHT AND
BUZZER 11, 16
SEATS 6, 7
SIDE VENTILATOR 11
SPARE TIRE 62
SPARK PLUGS 55
SPECIFICATIONS 86
SPEEDOMETER 11, 12
STARTING THE ENGINE 23 to 26
SUN VISOR 40
TACHOMETER 11, 19
TAILGATE LOCK 5, 42
TIPS ON DRIVING 29
TIRE CARE 59
TIRE INFLATION PRESSURES 51
TIRE RESERVE LOAD 94, 95
TIRE ROTATION 59
TOOLS 63
TOWING 44, 45
TRANSMISSION CONTROL LEVER 11
TRANSMISSION SELECT LEVER
 (Automatic Transmission) 11
TRIP ODOMETER RESET CONTROL 11
TURN SIGNAL INDICATOR LIGHTS 15
TURN SIGNAL SWITCH 17
VEHICLE STOPPING DISTANCE 92, 93
VENTILATION SYSTEM 33
VOLTMETER 11, 13, 14
WARNING AND INDICATOR LIGHTS
 Charge warning light 14
 Floor temperature warning light 11, 16, 22, 23
 Fuel warning light 11, 14
 Hazard warning 44
 High beam indicator light 15
 Parking brake warning light 15
 Rear defogger indicator light 11
 Seat belt warning light 11, 16
 Turn signal indicator lights 15
WATER TEMPERATURE GAUGE 11, 13
WHEEL AND TIRE 59
WINDSHIELD WASHER FLUID LEVEL 50
WINDSHIELD WIPER AND
 WASHER SWITCH 11, 18
WINDSHIELD WIPER BLADES 55

GAS STATION INFORMATION

FUEL RECOMMENDATION

Use an unleaded or low-lead gasoline with a minimum octane rating of 91 based on the Research Octane Number.

Note: In California models, only unleaded gasoline can be used.

The fuel filler opening is designed for use with an unleaded fuel gun [nozzle diameter less than 0.84 in (21.3 mm)] only.



ENGINE OIL ①

Check oil level at each fuel stop. Use only recommended engine oil and fill to the line "H" on dipstick. See page 53 for oil specifications and page 52 for oil viscosity.

BRAKE OIL ②

Check fluid level in brake reservoir. Use only recommended brake fluid. See page 53.

WINDSHIELD WASHER ③

Check fluid level in windshield washer tank.

RADIATOR COOLANT ④

Check coolant level.

BATTERY ⑤

Check fluid level monthly.

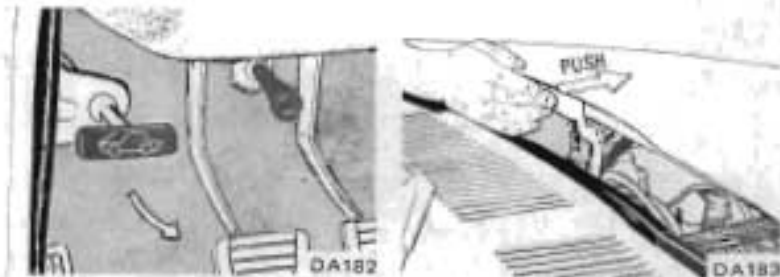
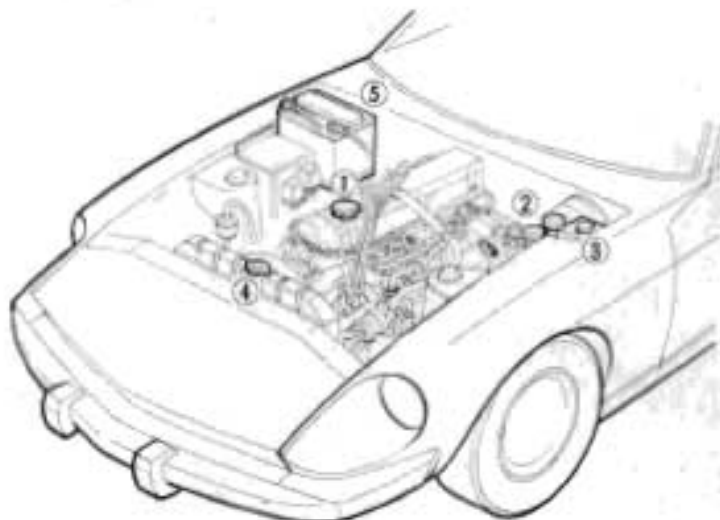

TIRE INFLATION PRESSURE

Keep inflated to pressures shown on tire placard affixed to glove box of your vehicle.

S30-D

CHECK YOUR **NISSAN/DATSUN**
GUARANTEE AND SERVICE BOOKLET
FOR
FULL DETAILS OF OUR
GUARANTEE TO
THE MOST IMPORTANT PERSON,
PURCHASER OF ONE OF
NISSAN/DATSUN'S NEW VEHICLES
THANK YOU!



Issued: October 1975 (401000)
Printed in Japan Publication No. OM8E-0830U2

NISSAN MOTOR CO., LTD.